



九齊科技股份有限公司  
Nyquest Technology Co., Ltd.

DATA SHEET

## NY1C Series

---

### LED Control and Drive Synthesizer with Synchronous Step-Up Converter

**Version 1.1**

**May 23, 2018**

---

NYQUEST TECHNOLOGY CO. reserves the right to change this document without prior notice. Information provided by NYQUEST is believed to be accurate and reliable. However, NYQUEST makes no warranty for any errors which may appear in this document. Contact NYQUEST to obtain the latest version of device specifications before placing your orders. No responsibility is assumed by NYQUEST for any infringement of patent or other rights of third parties which may result from its use. In addition, NYQUEST products are not authorized for use as critical components in life support devices/systems or aviation devices/systems, where a malfunction or failure of the product may reasonably be expected to result in significant injury to the user, without the express written approval of NYQUEST.

## Revision History

<b>Version</b>	<b>Date</b>	<b>Description</b>	<b>Modified Page</b>
1.0	2018/02/27	Formal release.	-
1.1	2018/05/23	<ol style="list-style-type: none"><li>1. Add new option for pull-low resistor.</li><li>2. Modify the voltage in UVLO.</li><li>3. Add package dimension.</li></ol>	3, 7, 10 5, 8 22

## 1. 概述

NY1C 系列產品為內建 Boost 升壓線路的 LED 控制驅動IC。此IC最低工作電壓可達1.0V，輸出電壓有2.7V / 3.0V / 3.3V / 3.5V四種可選，可根據不同應用來選擇不同輸出電壓(光罩選擇)，且特定條件下，最高轉換效率超過90%，並內建 過流 / 過溫 / 過壓 保護功能。此外，利用精準的內阻震盪故不需外加震盪電阻，每個Output可分別提供不同的電流輸出並搭配軟體電流控制來驅動不同亮度的LED，還可選擇定電流輸出以保護LED，故無須再外加限流電阻。閃燈合成方式為可程式的方波、斜線和曲線，可任意組成出各種閃爍方式，藉由製造過程中更換Code光罩，可將不同的閃燈資料寫入ROM中。用戶可使用簡便的 *Q-Light* 工具軟體來快速地進行開發。

## 2. 功能

- (1). 寬廣的工作電壓：1.0V ~ 4.2V。
- (2). 待機狀態的靜態電流(Isb)小於1uA。
- (3). 可支援的I/O腳和ROM大小如下：

P/N	NY1C007A
I/O	4*I/O, 3*O
ROM	1A40H

- (4). NY1C007A有7個I/O腳：OKY, IO1, IO2, IO3 可分別選擇作輸入腳或是輸出腳，O4, O5, O6 只能作為輸出腳來推LED，而IO3當作輸入腳時，只能選擇為模式切換開關(Mode-Switch)。(光罩選擇)
- (5). 閃燈最多可被分割成32個閃燈段(Section)，每段長度可不同，每一閃燈段中的閃燈採樣點數必須為40H (Hex)的整數倍。同個時間的每個採樣點可選擇的基本時間單位為1/128秒或1/16秒，並可搭配 x1, x2, x4, x8 的時間倍數(Extension)選項，因此每個採樣點共有7種時間長度可擇 (1/128, 1/64, 1/32, 1/16, 1/8, 1/4, 1/2 秒)。
- (6). NY1C007A 最多有512個閃燈格(Step)，可規劃成32個閃燈組(Sentence)，OKY、IO1、IO2 能分別指定 32、1、1 個閃燈組(Sentence)。每一閃燈格(Step)可指定任一個閃燈段(Section)和 OKY、IO1、IO2、IO3、O4、O5、O6 的輸出搭配 (當IOx設為輸出時)。

*※ 注意：IO3當輸入腳時只能用來做為模式切換開關 (Mode-Switch)，並不能用來指定閃燈組。*

- (7). 閃燈最多為5通道或7通道輸出(所有I/O都設為輸出腳)，每個通道可分別自訂一組可程式的PWM方波(Flashing)或漸明漸暗的斜線(Ascend/Descend)。每段方波還可分別定義成0%~100%不同的高度，不同的高度設定可以讓LED產生不同的亮度變化，而每段斜線最多有128階變化，可以讓LED產生漸明或漸暗的效果。
- (8). 只有內建一組準確的頻率振盪器(+/-1% 誤差)，並無提供外部震盪電阻選項。
- (9). 輸入腳的輸入選項：(光罩選擇)
  - (a). 任一輸入腳可分別選擇 Edge/Level, Hold/Unhold, Retrigger/Irretrigger 不同的觸發方式組合。
  - (b). 任一輸入腳可分別選擇 **CDS+300K (Strong)** 或 **CDS+360K (Weak)**、**CDS、300K (Strong)** 或 **360K (Weak)** 的下拉電阻、Floating。當應用為1.5V (一顆電池) 會被選為**Strong**，應用為3.0V (兩顆電池) 會被選為**Weak**，請注意Strong應用在3.0V時會有較大的輸入電流，造成較大的耗電；而Weak應用在1.0V時會因為電阻值是10M歐姆，接近 Floating，容易發生誤觸發。(CDS+300K 或 CDS+360K 選項: 當按鍵按下時，IC內部為 **300K 或 360K** 的下拉電阻；而當按鍵放開時，IC內部為 **200K+300K 或 40K+360K** 並聯

的下拉電阻 約 **120KΩ** 或 **36KΩ**。CDS選項：當按鍵按下時，IC內部為 Floating；而當按鍵放開時，IC內部為 **200KΩ (1.5V)** 或 **40K (3V)** 的下拉電阻。)

- (c). 任一輸入腳可分別選擇Debounce時間：Long – 10ms 給一般按鍵使用；Short – 50us 給彈跳開關使用。
- (d). OKY輸入腳最多有32個Sentence的One-Key Sequential 或 Random 的選擇，在 One-Key Sequential 時並可選擇Sentence的播放順序在其他按鍵被觸發後是否要Reset。
- (e). 只有OKY輸入腳可選擇是否有 Toggle On/Off 的功能 (1<sup>st</sup> 觸發 → 播放，2<sup>nd</sup> 觸發 → 停止，.....)。

*※ 注意：按鍵輸入的優先順序為 OKY > IO1 > IO2。*

(10). 所有的輸出腳都有以下 3 種輸出選項：(光罩選擇)

- (a). Large Sink Current Output (大灌電流輸出)：輸出腳接LED到VDD。(I<sub>ol</sub>=60mA @V<sub>out</sub>=3.5V)
- (b). Constant Sink Current Output (定灌電流輸出)：輸出腳接LED到Vout，輸出電流為恆定電流，不會因為Vout不同而影響到LED亮度。(I<sub>ol</sub>=20mA/30mA @V<sub>out</sub>=2.7V/3.0V/3.3V/3.5V)
- (c). Drive Current Output (拉電流輸出)：輸出腳接LED到GND。(I<sub>oh</sub>=10mA @V<sub>out</sub>=3.5V)

(11). 每個輸出腳都可分別設定為不同的電流：(光罩選擇)

- (a). Large Sink Current (大灌電流)：提供4種不同輸出電流 100%, 83%, 50%, 33%。
- (b). Constant Sink Current (定灌電流)：提供4種不同輸出電流 100%, 83%, 50%, 33%。
- (c). Drive Current (拉電流)：只有一種電流 100%。

(12). 特殊功能選項 “模式切換” (Mode-Switch)：有兩種功能模式，可使用IO3輸入來當作模式切換開關(Mode-Switch)，模式一(IO3→GND) 與 模式二(IO3→VDD) 的所有輸出型態(輸出選項和電流)只能相同，但是I/O功能和閃燈內容可以不同。在模式一和模式二的狀態下，OKY最多只能分別指定16個閃燈組(Sentence)。

*※ 注意：IO3 建議設為 Floating Input 以避免有一定的輸入電流存在。*

(13). 特殊功能選項 “上電播放” (Power-On-Play, POP)：電池一上電立即播放一次”上電播放閃燈組”(POP Sentence) 或是循序播放OKY的所有閃燈組一次，觸發模式固定為 Edge / Unhold / Retrigger。如果POP結合 Power-On-Loop (POL) 功能，則上電會循環播放 “上電播放閃燈組” (POP Sentence) 或是循序循環播放 OKY的所有閃燈組，直到其他按鍵被觸發才會停止，當其他按鍵被觸發時，上電播放會立即停止並播放該按鍵所指定的閃燈組。如果POP結合Mode-Switch功能，則當模式切換後會先執行上電播放。

(14). 特殊功能選項 “短觸發循環播放” (Edge-Loop)：當OKY按鍵一被觸發，該觸發按鍵所指定的閃燈組會一直循環播放。如果結合 One-Key Sequential 功能，再次觸發該按鍵，會循環播放下一個閃燈組。如果結合 Loop On/Off 功能，再觸發該按鍵，閃燈會停止，再次觸發則循環播放下一個閃燈組。如果結合 Loop-End 功能，在播放OKY最後一個閃燈組時再次觸發該按鍵，閃燈會停止，再次觸發則回到第一個閃燈組進行循環播放。如果結合 Level-Stop 功能，在播放OKY的閃燈組時，持續2秒按著該按鍵，閃燈會停止，再次觸發則跳到下一個閃燈組進行循環播放。

*※ 注意：Toggle On/Off, Loop On/Off, Loop-End 和 Level-Stop等四種停止功能，除了 Loop-End 和 Level-Stop 可同時存在外，其餘停止功能只能選擇其一。*

(15). 特殊功能選項 “長觸發順序循環播放” (Level-Sequential)：當OKY按鍵被觸發後持續按著，會依序播放OKY所指定的閃燈組，一直循環播放 (S1, S2, S3, S1, S2, S3.....)，按鍵離開則閃燈立即停止(Hold mode)或播完該閃燈組後停止(Unhold mode)，再按著按鍵則播放下一個閃燈組，然後仍然依序循環播放。如果結合

Edge-Loop功能，OKY按鍵被觸發後(不需持續按著)，會依序播放OKY所指定的閃燈組，一直循環播放，再次觸發該按鍵，會立即播放下一個閃燈組，然後仍然依序循環。如果結合Edge-Loop 和 Loop On/Off 功能，再次觸發該按鍵，閃燈會停止，再次觸發則播放下一個閃燈組，然後仍然依序循環播放。

- (16). 特殊功能選項“暫停/恢復播放”(Pause-Resume)：在播放OKY的閃燈組時，當OKY按鍵一被觸發，則閃燈組會暫停播放，此時LED全滅，IC會進入睡眠狀態(Sleep Mode)，靜態電流非常小(0.05uA)，再次觸發OKY則會從之前閃燈組暫停的地方恢復播放。當使用此功能時，所有的停止功能都會沒有作用，例如：Toggle On/Off, Loop On/Off, Loop-End 和 Level-Stop 等停止功能。

*※ 注意：Pause-Resume不能和其他停止功能同時存在。*

- (17). 特殊功能選項“雜訊觸發”(Noise-Trigger)：當選擇此功能時，OKY被設定為 Edge/Unhold 功能，應用時需將OKY輸入在PCB的Layout做成較長的輸入線，當外部有較大的雜訊產生時，利用天線效應的原理來產生輸入訊號，OKY外部懸空不需連接到VDD或GND腳。(此功能常見於電子打火機和手機天線的應用)
- (18). 序列觸發功能(Serial-Trigger)：在 Edge/Unhold/Retrigger 觸發模式下，使用OKY的 One-Key Sequential 和 Reset 功能，並設定觸發Debounce時間為Short Debounce，這樣就可以利用外部序列訊號輸入來控制OKY的特定Sentence播放，通常搭配外部MCU來控制。
- (19). Boost 升壓線路，輸出電壓 2.7V / 3.0V / 3.3V / 3.5V (+/- 3% 誤差)，輸出電壓越低則升壓轉換效率越高。
- (20). 同步設計轉換效率超過90%。
- (21). 內建 500KHz 固定振盪頻率提供給升壓線路。
- (22). 內建 過流 / 過溫 / 過壓 保護功能。
- (23). 內建UVLO，低於2.8V IC不工作，用於鋰電池保護。(光罩選擇)

## 1. GENERAL DESCRIPTION

The NY1C series are built-in boost circuit LED Control and Drive IC. The minimum operating voltage of NY1C series are down to 1.0V and the output voltage is available at 2.7V / 3.0V / 3.3V / 3.5V. User can select different output voltages (Mask option) according to different applications. NY1C series have built-in protection: Over Current / Over Temperature / Over Voltage. Under certain conditions, the maximum conversion efficiency is more than 90%. Through the accurate internal oscillation of built-in Rosc, an external Rosc is not required. Each output can provide different kinds of current output cooperating with software current control to drive different brightness LED, and optional constant current is also provided to protect LED, thus it's not necessary to add the external current-limit resistor. The LED pattern consists of programmable square waveform, oblique and curve, user can compose varied pattern and then the customized LED data can be programmed into ROM by changing one code mask during fabrication. Besides, the interactive software developing tool of "Q-Light" is user-friendly and quick for programming.

## 2. FEATURES

- (1). Wide operating voltage: 1.0V ~ 4.2V.
- (2). Standby current is less than 1uA.
- (3). The I/O counts and maximum ROM size are as following.

P/N	NY1C007A
I/O	4*I/O, 3*O
ROM	1A40H

- (4). NY1C007A has 7 I/O pins: OKY, IO1, IO2 and IO3 can be either input or output pin. The O4, O5 and O6 can only be output pin. When IO3 is set as input, it's Mode-Switch function only. (Mask option)
- (5). The total LED pattern can be partitioned up to maximum 32 *LED Sections*. Each *LED Section* length is flexible. The *LED Section* data length must be the multiple of 40H (Hex). The time unit of each LED sample can be 1/128 sec or 1/16 sec. Cooperating with time extension option of x1, x2, x4 and x8, there are total 7 options selectable. (1/128, 1/64, 1/32, 1/16, 1/8, 1/4, 1/2 sec)
- (6). For NY1C007A, maximum 512 *LED Steps* are available for 32 *LED Sentences*. OKY, IO1 and IO2 input can assign 32, 1 and 1 *Sentences* independently. Each *Step* can specify one *LED Section* and enable/disable OKY, IO1, IO2, IO3, O4, O5 and O6 output option if IOx is set as output.

*※ Note: When IO3 is set as input, it can only be Mode-Switch function and can't be assigned a LED Section.*

- (7). There are maximum 5 or 7 channels of LED. Each channel can be assigned one set of programmable PWM square waveform (Flashing) and/or fade-in/fade-out oblique (Ascend/Descend). Every PWM square waveform can be set as different level of 0%~100% amplitude to control the LED brightness, and every oblique has maximum 128 levels variation to generate fade-in or fade-out effect.
- (8). Only build in an accurate internal oscillator of +/- 1% tolerance, no external R oscillator.

- (9). Input option for input pin. (Mask option)
- Each input can select Edge/Level, Hold/Unhold and Retrigger/Irretrigger trigger modes.
  - Each input can select **CDS+300K (Strong) or CDS+360K (Weak)**, CDS, **300K (Strong) or 360K (Weak)** pull-low resistor, or Floating type. **It is recommended to select Strong / Weak at 1.5V (one battery) / 3.0V (two batteries). Please note using Strong option at 3.0V will have more input current to cause greater power consumption; and the Weak option can't be used at 1.0V because the resistance is about 10M ohms that will cause false trigger.** (CDS+300K or CDS+360K option: Only **300K $\Omega$  or 360K $\Omega$**  pull-low resistance at key-pressed, and **200K $\Omega$ +300K $\Omega$  or 40K $\Omega$ +360K $\Omega$**  in parallel pull-low resistance around **120K $\Omega$  or 36K $\Omega$**  at key-released. CDS option: Floating at key-pressed, and **200K $\Omega$  (1.5V) or 40K $\Omega$  (3V)** pull-low resistance at key-released.)
  - Each input can select Debounce time: Long debounce of 10ms for push-button. Short debounce of 50 $\mu$ s for fast switch.
  - Only OKY input can select One-Key Sequential or Random for maximum 32 *Sentences* independently. At One-Key Sequential, the Reset function of playing *Sentence* sequence can be enabled or disabled when other keys are triggered.
  - Only OKY input can select Toggle On/Off function (1<sup>st</sup> Trigger  $\rightarrow$  play, 2<sup>nd</sup> trigger  $\rightarrow$  stop, .....).
- ※ Note: Input priority is OKY > IO1 > IO2.**
- (10). There are 3 kinds of output option for all output pins. (Mask option)
- Large Sink Current output: Output is connected a LED with VDD. ( $I_{ol}=60\text{mA}$  @ $V_{out}=3.5\text{V}$ )
  - Constant Sink Current output: Output is connected a LED with  $V_{out}$ . The output current is constant and LED brightness is uniform. ( $I_{ol}=20\text{mA}/30\text{mA}$  @ $V_{out}=2.7\text{V}/3.0\text{V}/3.3\text{V}/3.5\text{V}$ )
  - Drive Current output: Output is connected a LED with GND. ( $I_{oh}=10\text{mA}$  @ $V_{out}=3.5\text{V}$ )
- (11). There are different current options for each output pin. (Mask option)
- Large Sink Current: 4 kinds of sink current output, 100%, 83%, 50%, 33%.
  - Constant Sink Current: 4 kinds of constant sink current output, 100%, 83%, 50% and 33%.
  - Drive Current: only one kind of drive current output, 100%.
- (12). “Mode-Switch” special function: There are two kinds of functional modes that can be switched by IO3 input (Mode-Switch). For Mode-1 (IO3  $\rightarrow$  GND) and Mode-2 (IO3 $\rightarrow$ VDD), the output type (output option and output current) of I/O setting is the same, but I/O function and LED pattern can be different. At Mode-1 and Mode-2, the OKY can specify maximum 16 sentences respectively.
- ※ Note: IO3 is suggested to set as Floating Input to avoid an input current occurred.**
- (13). “Power-On-Play” special function (POP): When power is on, play the POP Sentence one time. The trigger mode is fixed as Edge / Unhold / Retrigger. To cooperate with *Power-On-Loop (POL)* function, the POP Sentence will be played in loop until other key-trigger happened. When other key is triggered, it stops playing the POP Sentence and immediately plays the assigned sentence of triggered key. To cooperate with *Mode-Switch* function, the POP Sentence will be played first when mode is switched.

(14). “Edge-Loop” special function: When OKY is triggered, playing the assigned sentence in loop. To cooperate with One-Key Sequential function, playing the next assigned sentence in loop once key is triggered again. To cooperate with Loop On/Off function, stop playing if triggered once more, and play the next assigned sentence in loop once key is triggered again. To cooperate with Loop-End function, stop playing if triggered once more when playing the last sentence of OKY, and play the first sentence in loop once key is triggered again. To cooperate with Level-Stop function, stop playing if key is held for 2 seconds when playing the sentence of OKY, and play the next sentence in loop once key is triggered again.

*※ Note: Toggle On/Of, Loop On/Off, Loop-End and Level-Stop cannot be optioned together, except Loop-End and Level-Stop. Only one kind of stop function can be selected.*

(15). “Level-Sequential” special function: When OKY is triggered and held, playing the assigned sentences sequentially in loop (S1, S2, S3, S1, S2, S3...), after key is released, stop playing at Hold mode or playback the sentence at Unhold mode. Holding key again to play the next sentences sequentially in loop as usual. To cooperate with Edge-Loop function, playing the assigned sentences sequentially in loop when OKY is triggered and not held. Trigger once more to play the next sentences sequentially in loop as usual. To cooperate with both Edge-Loop and Loop On/Off function, stop playing if triggered once more, and play the next sentences sequentially in loop once key is triggered again.

(16). “Pause-Resume” special function: At playing OKY sentence, when key is triggered, the sentence will pause, all LEDs are turned off and IC will enter sleep mode. At this moment, the standby current is very small about 0.05uA. To trigger OKY again, the sentence will resume and play sentence from the pause point. While using this function, all STOP function will be disabled, such as Toggle On/Off, Loop On/Off, Loop-End and Level-Stop.

*※ Note: Pause-Resume function cannot co-exist with other stop function.*

(17). “Noise-Trigger” special function: When this function is selected, OKY is set as Edge/Unhold function. In PCB layout, OKY input needs a longer input line. By antenna effect, it takes place an input signal when larger noise happens outside. OKY is floating externally and is not necessary to connect to VDD or GND. It’s popular in electric lighter or mobile antenna application.

(18). Serial-Trigger function: In Edge/Unhold/Retrigger mode, by using the One-Key Sequential and Reset functions of OKY and setting the Debounce time to be short, IC can access external serial clock signal to playback the specific Sentence of OKY. Usually it cooperates with an external MCU.

(19). Boost circuit, the output voltage is available at 2.7V / 3.0V / 3.3V / 3.5V. (+/- 3% tolerance)

(20). Up to 90% Efficiency.

(21). 500KHz fixed switching frequency.

(22). Built-in protection: Over Current, Over Voltage, Over Temperature.

(23). Built-in UVLO. (Less than 2.8V, IC does not work for Li battery protection, Mask option)



### 3. BLOCK DIAGRAM

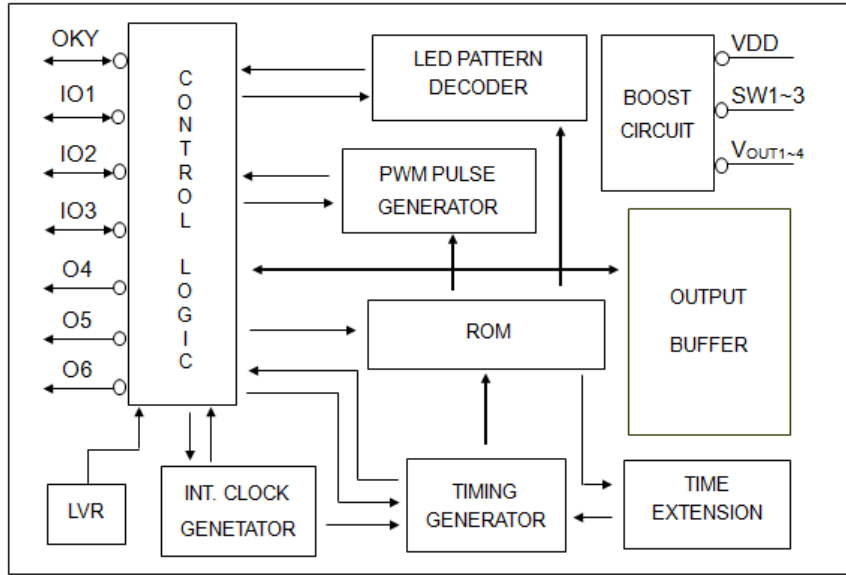

### 4. PAD DESCRIPTION

Pad Name	Pad No.	ATTR.	Description
GND1~4	1~3, 13	Power	Negative power.
SW1~3	4~6	I	Switch pin. Connect an inductor between SW and VDD.
VOUT1~4	7~10	O	Boost output.
OKY	11	I/O	Input or output pin. To be input, active high.
IO1	12	I/O	Input or output pin. To be input, active high.
IO2	14	I/O	Input or output pin. To be input, active high.
IO3	15	I/O	Input or output pin. To be input, it's Mode-Switch function.
O4	16	O	Output pin.
O5	17	O	Output pin.
O6	18	O	Output pin.
VDD	19	Power	Positive power.

### 5. DEVELOPMENT, DEMONSTRATION

User can use “Q-Light” software tool to develop the desired functions. After finishing the code programming, user will get 2 files of “.bin” and “.htm”, the binary file and function checking list. Through “FDB\_Writer” operation, user can download the “.bin” file into NY1\_FDB flash demo board to demonstrate the NY1C function. Once the function has been approved, user only needs to send the “.bin” file to Nyquest for code release. For more details, please refer to “Q-Light” user manual.

2Mb Flash Demo board	NY1_FDB-02 (No Boost function)
Max. demo body	NY1C007A

**6. ABSOLUTE MAXIMUM RATING**

Symbol	Rating	Unit
VDD~GND	-0.5 ~ +6.0	V
Vin	GND-0.3 < Vin < VDD+0.3	V
T <sub>op</sub> (operating)	-0 ~ +70	°C
T <sub>st</sub> (storage)	-55 ~ +150	°C

**7. DC CHARACTERISTICS** (*Inductor=4.7uH, T<sub>A</sub>=25°C, unless otherwise specified*)

Symbol	Parameter	Min.	Typ.	Max.	Unit	Condition	
VDD	Operating voltage	0.9	---	4.2	V	VDD < V <sub>out</sub> + 0.7V	
V <sub>out</sub>	Output voltage range	2.6	---	3.6	V	2.7V / 3.0V / 3.3V / 3.5V options	
F <sub>osc</sub>	Switching Frequency	---	500	---	KHz		
D <sub>max</sub>	Maximum duty	---	88	---	%		
R <sub>DSON_P</sub>	PMOS switch on resistance	---	0.45	---	Ω	V <sub>out</sub> = 3.5V, I <sub>sw</sub> = 500mA	
R <sub>DSON_N</sub>	NMOS switch on resistance	---	0.35	---	Ω	V <sub>out</sub> = 3.5V, I <sub>sw</sub> = 500mA	
I <sub>op</sub>	Operating current	---	2.3	---	mA	VDD = 1.5V, V <sub>out</sub> = 3.5V	
I <sub>sb</sub>	Standby current	---	0.5	1	uA		
I <sub>out</sub>	Total output current	---	150	---	mA	VDD = 1.1V~4.2V, V <sub>out</sub> = 3.5V	
I <sub>ih</sub>	Input current	Strong (300K ohms pull low @ VDD = 1.5V)	---	0.5	---	uA	VDD = 1V
			---	5	---	uA	VDD = 1.5V
			---	47	---	uA	VDD = 3.0V
		Weak (360K ohms pull low @ VDD = 3.0V)	---	0.1	---	uA	VDD = 1V (False trigger happen)
			---	0.9	---	uA	VDD = 1.5V
			---	8.3	---	uA	VDD = 3.0V
I <sub>oh</sub>	Output drive current	---	10	---	mA	VDD = 1.5V, V <sub>out</sub> = 3.5V, V <sub>oh</sub> = 2.5V	
I <sub>ol</sub>	Output large sink current (100%)	---	60	---	mA	VDD = 1.5V, V <sub>out</sub> = 3.5V, V <sub>ol</sub> = 1V	
	Output constant sink cut (100%)	---	20 or 30	---	mA		
V <sub>uvlo</sub>	Under voltage lockout	---	2.8	---	V	UVLO enabled	
I <sub>ocp</sub>	Over current protection	---	1.2	---	A	V <sub>out</sub> = 3.5V	
V <sub>ovp</sub>	Over voltage protection	---	5.6	---	V		
T <sub>tsd</sub>	Thermal shutdown	---	140	---	°C	Junction temperature	
T <sub>tsdh</sub>	Thermal shutdown hysteresis	---	30	---	°C		
Eff.	Boost efficiency	---	66	---	%	VDD = 1.1V, I <sub>out</sub> = 150mA @ V <sub>out</sub> = 3.5V	
		---	83	---	%	VDD = 1.5V, I <sub>out</sub> = 150mA @ V <sub>out</sub> = 3.5V	
		---	92	---	%	VDD = 2.4V, I <sub>out</sub> = 150mA @ V <sub>out</sub> = 3.5V	

**8. AC CHARACTERISTICS**

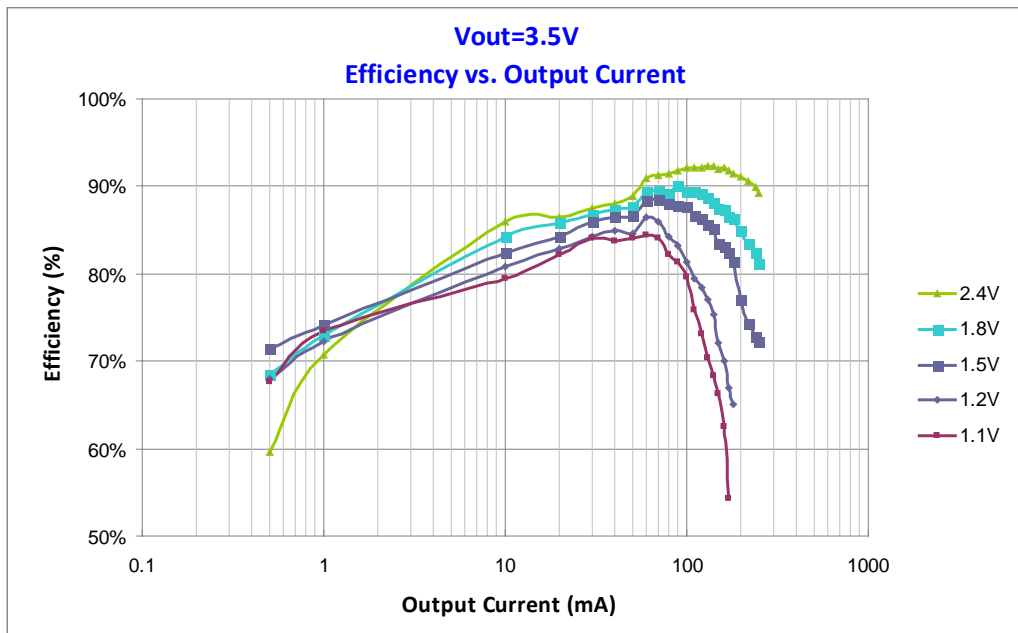
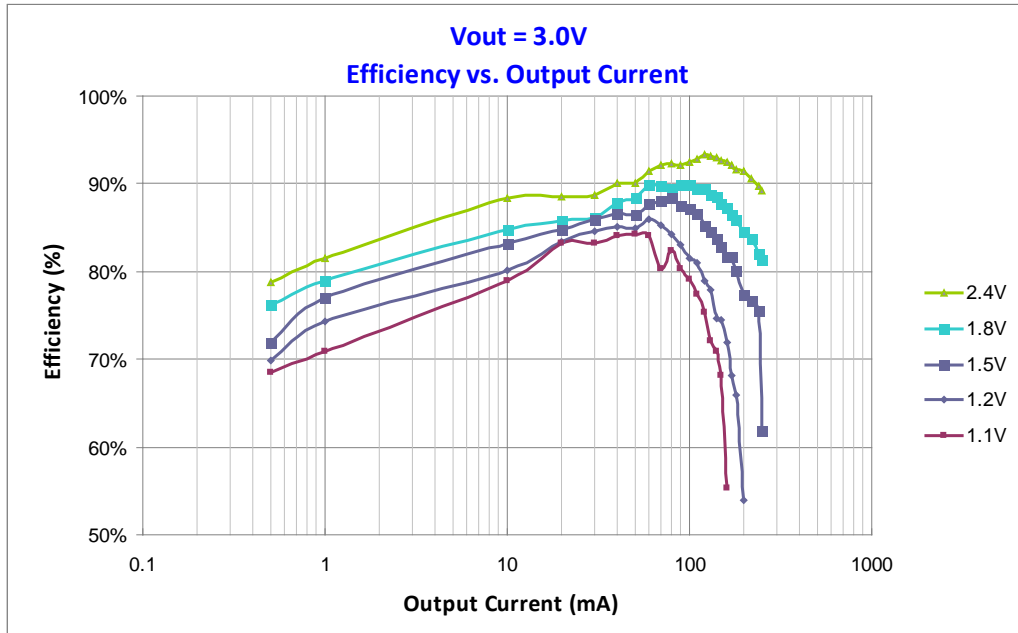

**9. TIMING DIAGRAM**

**(1) Debounce Time**

**(a). Trigger while not playing LED**

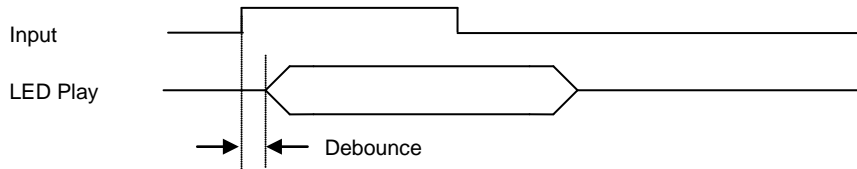

※ Debounce time is configured by Long debounce = 10ms, Short debounce = 50us

**(b). Trigger While playing LED**

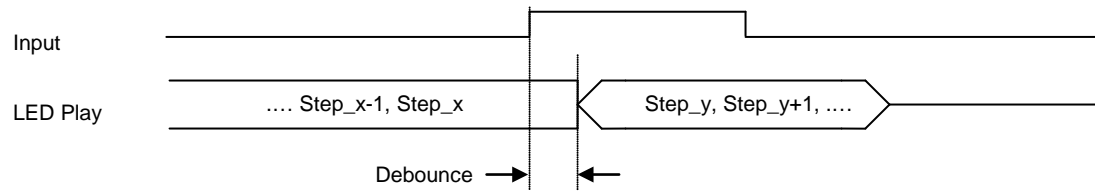

**(2) Input Priority**

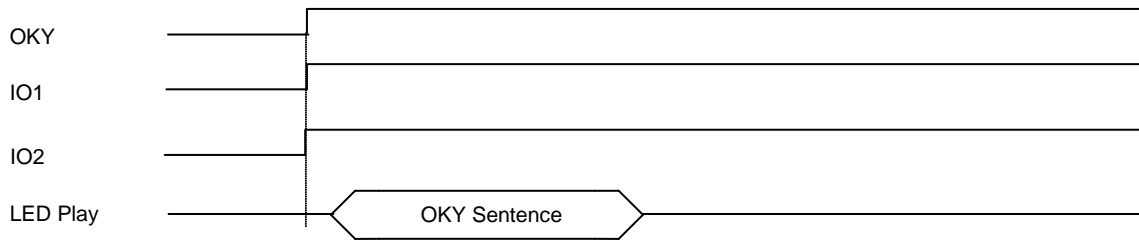

※ Priority: OKY > IO1 > IO2 > POP (Power-On-Play)

**(3) Basic Operation**

**(a). Edge mode, Edge trigger**

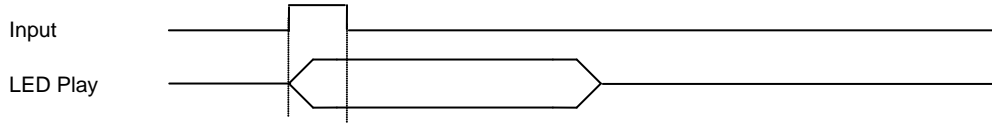

**(b). Edge mode, Level trigger**

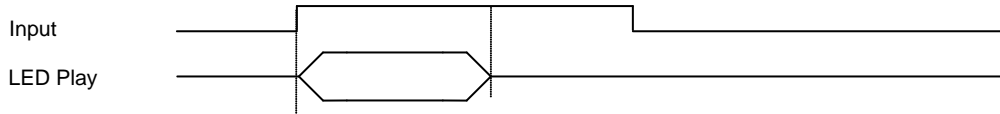

**(c). Level mode, Edge trigger**

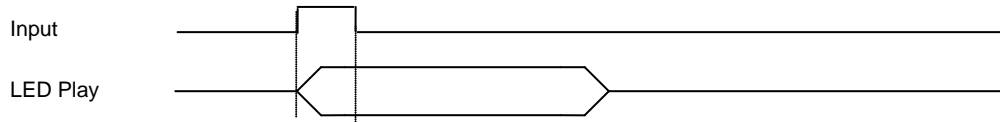

**(d). Level mode, Level trigger**

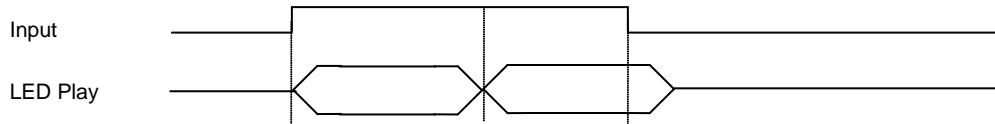

**(e). Retrigger mode**

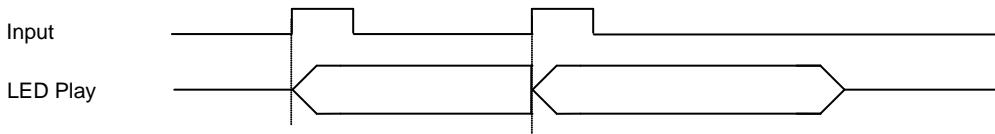

**(f). Irretrigger mode**

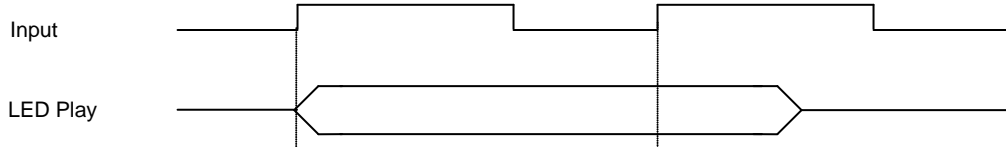

**(g). Retrigger mode, first key priority**

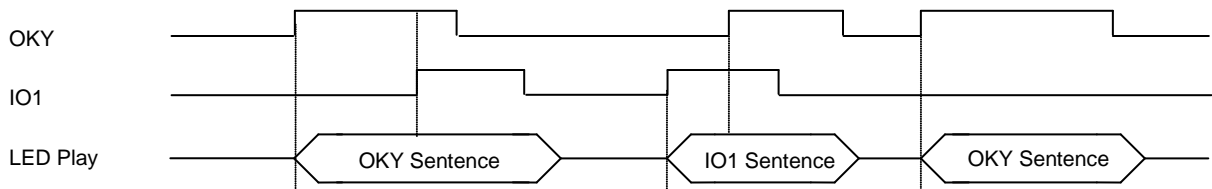

(4) Advanced Operation

(a). Different Input Reload ( OKY is in Sequential mode )

(a-1) OKY (E/U/R) = S1 S2 S3 S4, IO1(E/U/R) = S5 (S1 means Sentence 1)

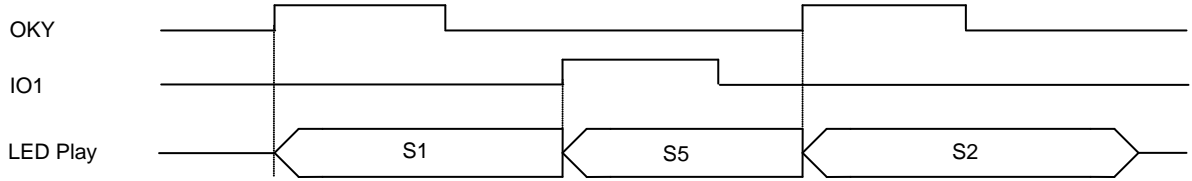

(a-2) OKY (E/U/R) = S1 S2 S3 S4, IO1 (L/x/x) = S5

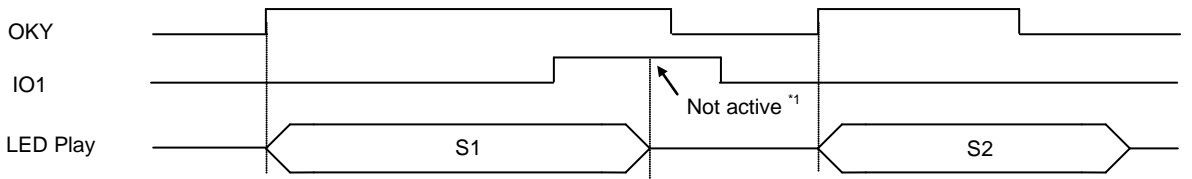

\*1: If you press IO1 during OKY LED playing, at the moment of S1 end, the trigger mode follows OKY

(a-3) OKY (E/U/I) = S1 S2 S3 S4, IO1 (E/x/x) = S5

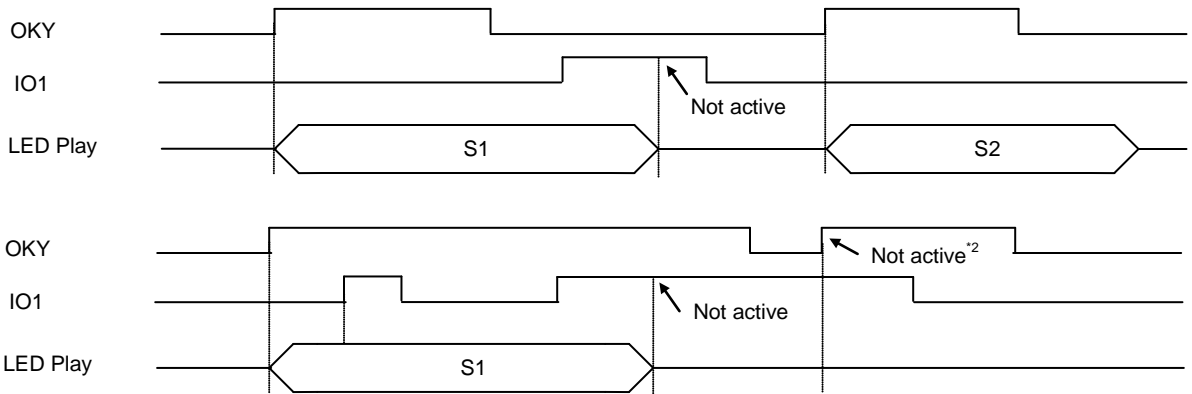

\*2: Because IO1 signal is still high, in the same time IC can't accept the OKY Edge signal.

(a-4) OKY (E/U/I) = S1 S2 S3 S4, IO1 (L/x/x) = S5

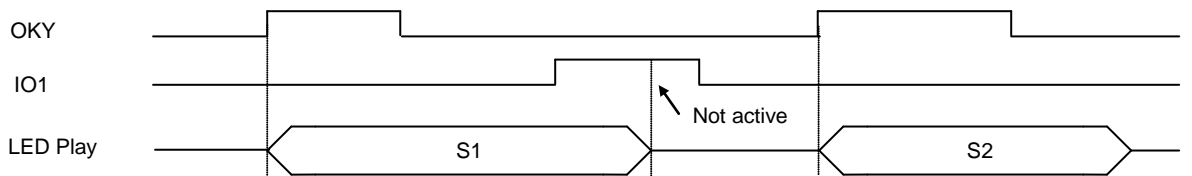

(a-5) OKY (L/U/x) = S1 S2 S3 S4, IO1 (E/x/x) = S5

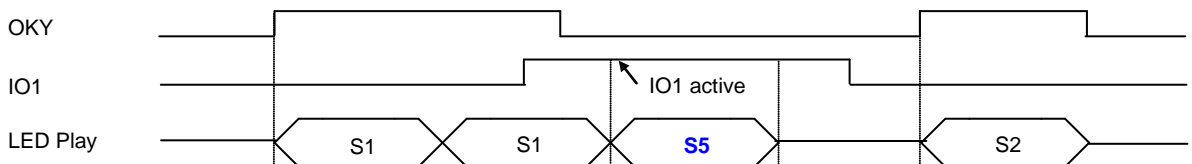

※ In the time of Sentence end: When S1 end, the trigger mode follows OKY (L/U/x). When S5 end, it follows IO1 (E/x/x).

※ Once S5 is played (just leave S1 ending), the trigger mode follows IO1 (E/x/x) immediately.

(a-6) OKY (L/U/x) = S1 S2 S3 S4, IO1 (L/U/I) =S5

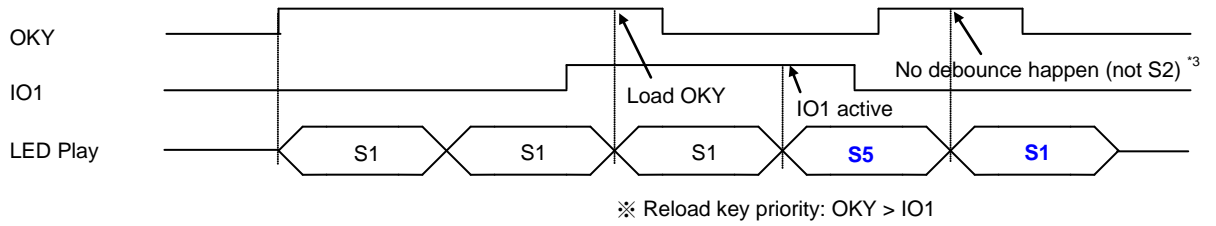

\*3: In OKY mode, Sequential number is counted only if there is debounce happened.

(a-7) OKY (L/U/x) = S1 S2 S3 S4, IO1 (L/U/x) =S5

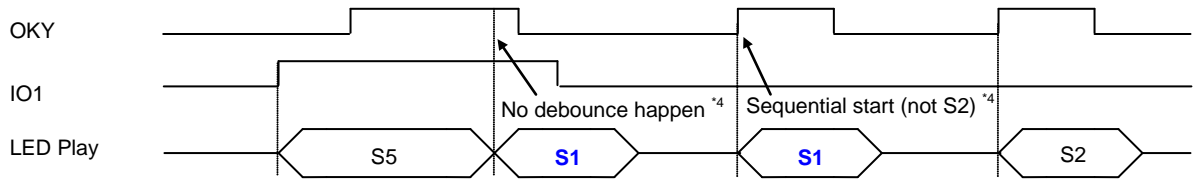

\*4: In OKY mode, 1<sup>st</sup> trigger without debounce and Sequential number is still "1". 2<sup>nd</sup> trigger with debounce, after trigger the Sequential number become "2".

**(b). Random Function**

(b-1) OKY (L/U/I) =S1 S2 S3 S4, IO1 (L/U/I) =S5

Random (or Sequential) number is counted during "debounce time" or "key released time". But the first-time trigger only relies on "debounce time" due to no "key release time".

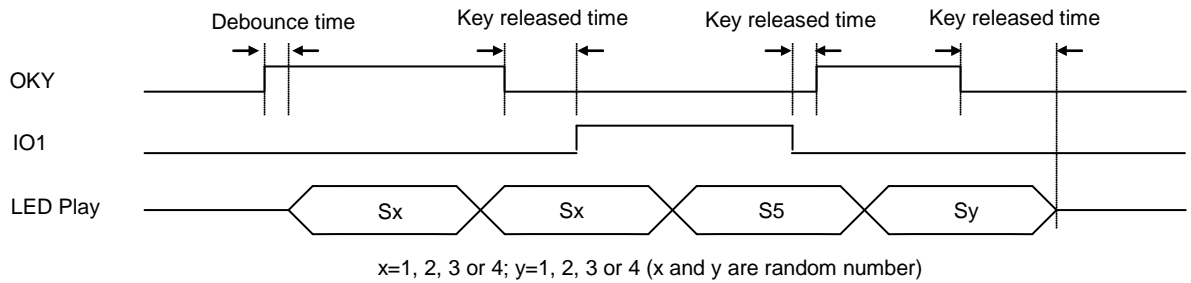

(b-2) OKY (L/U/R) =S1 S2 S3 S4, IO1 (L/U/R) =S5

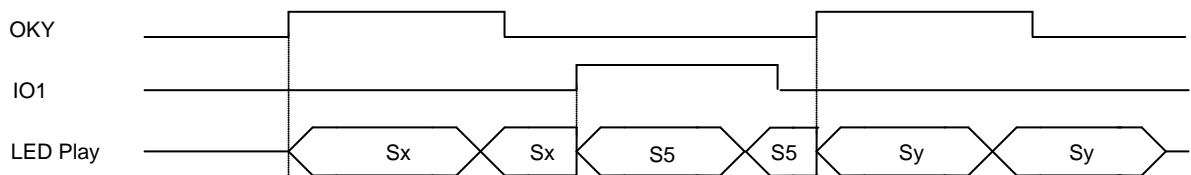

**(c). Toggle On/Off Function**

(c-1) OKY (E/U/R) = S1 S2 S3 S4, IO1 (E/U/R) = S5 (OKY is Sequential mode without Reset)

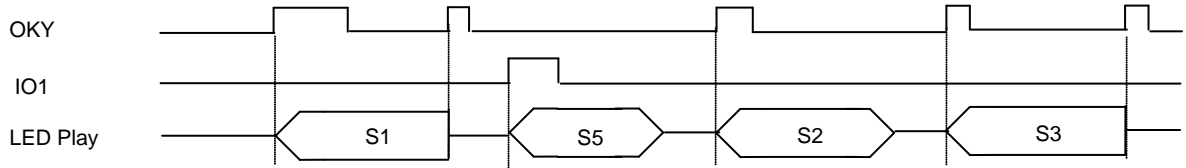

(c-2) OKY (E/U/R) = S1 S2 S3 S4, IO1 (E/U/R) = S5 (OKY is Sequential mode with Reset)

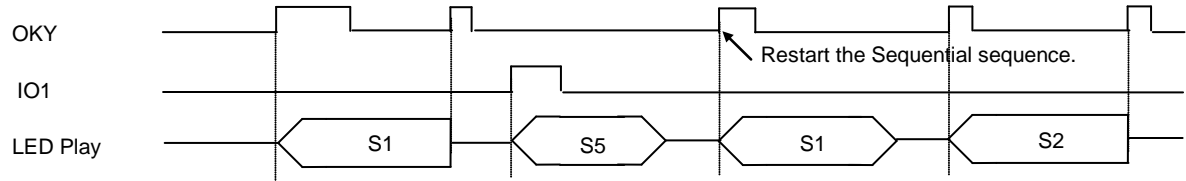

※ When OKY Sequential counter is going, to trigger other inputs will reset OKY Sequential sequence.

**(d). External Feedback Function ( IO1 is output and connected to OKY input )**

OKY (E/U/I) = S1 S2 S3 S4, IO1= Sink Mode (When not playing LED, IO1 is high, i.e. Busy\_Low.)

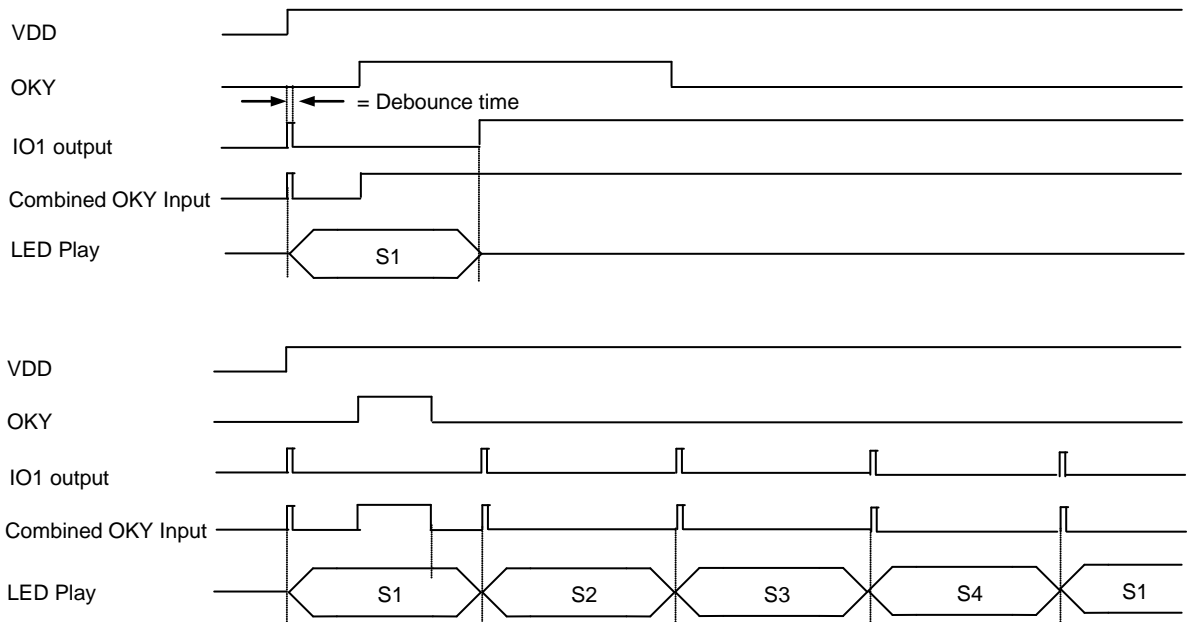

※ When power on, IO1 will generate a high pulse at Busy\_low status and the duration is equal to debounce time.



**(e). Mode-Switch Function**

If IO3 is set as Mode-Switch input, IO3→GND is for Mode-1 and IO3→VDD is for Mode-2.

(e-1) OKY (E/U/R) = S1 S2 S3 (Mode-1) & S17 S18 (Mode-2)

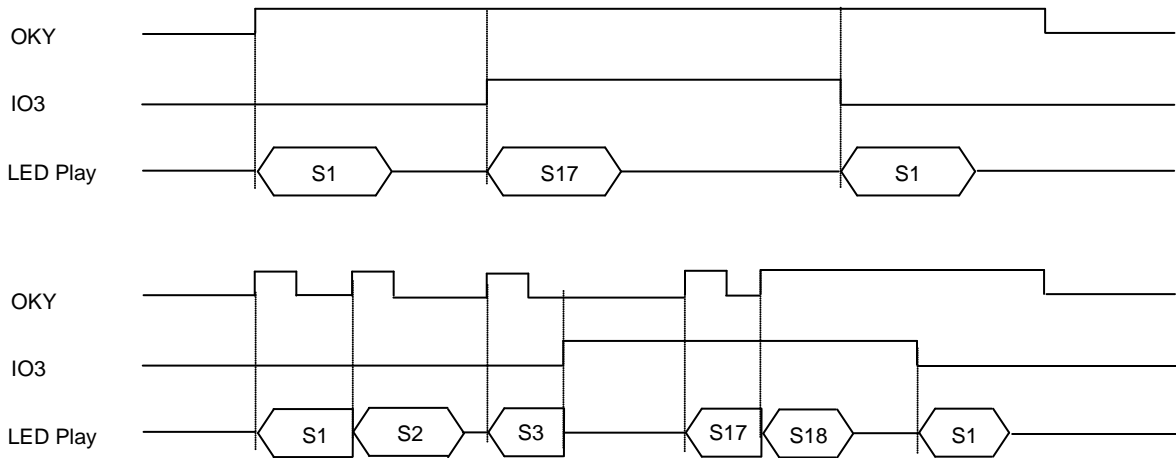

(e-2) OKY (E/U/R) = S1 S2 S3 (Mode-1) & S17 S18 ( Mode-2), POP (E/U/R) =S5

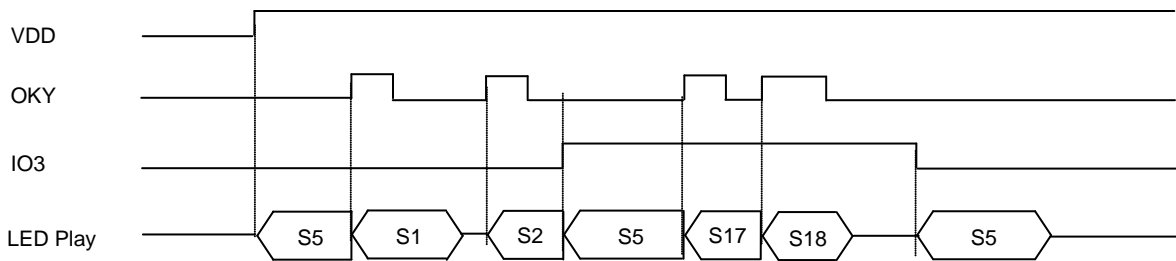

**(f). Power-On-Play (POP) Function**

The trigger mode of Power-On-Play is fixed as E/U/R, other trigger signal will stop POP's LED immediately and play the interrupted trigger's LED. POP can cooperate with Power-On-Loop function to play POP Sentence in loop.

(f-1) OKY (E/U/I) = S1 S2 S3, POP (E/U/R) =OKY

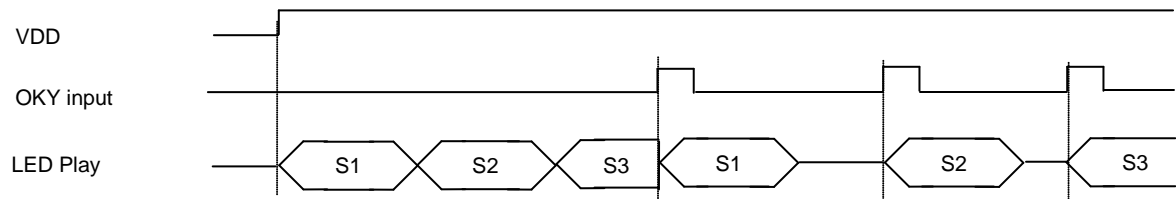

(f-2) OKY (E/U/I) = S1 S2 S3, POP (E/U/R) =S4, Power-On-Loop (POL) is enabled.

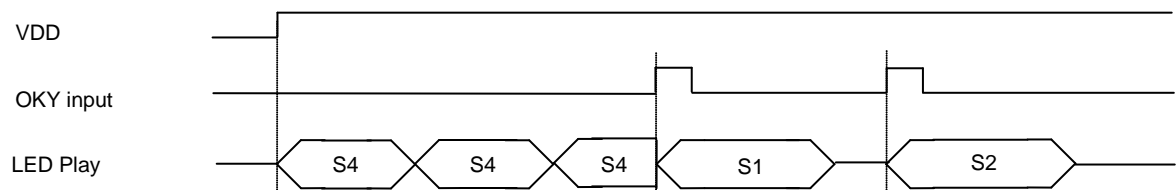

**(g). Edge-Loop Function**

(g-1) OKY (E/U/R) = S1 S2 S3

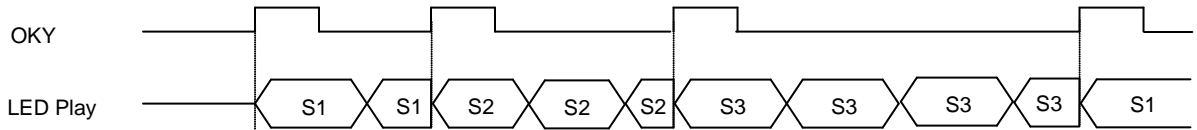

(g-2) OKY (E/U/R) = S1

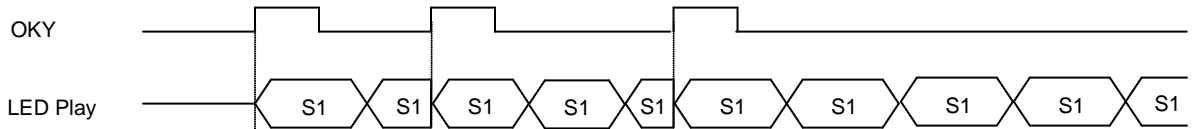

(g-3) OKY (E/U/R) = S1 S2 S3, Loop On/Off is enabled.

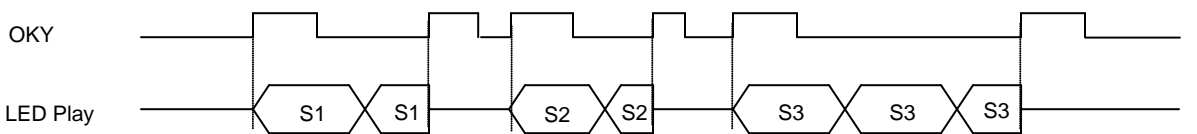

(g-4) OKY (E/U/R) = S1 S2 S3, Loop-End is enabled.

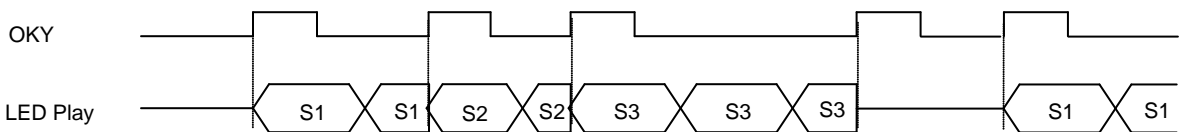

(g-5) OKY (E/U/R) = S1 S2 S3, Level-Stop is enabled.

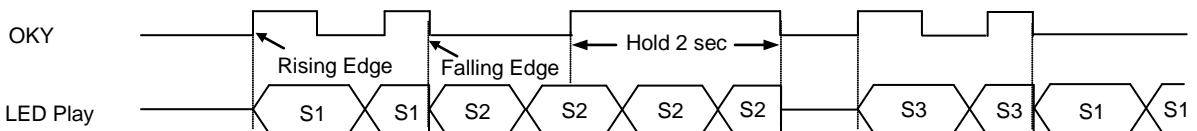

**(h). Level-Sequential Function**

(h-1) OKY (L/U/R) = S1 S2 S3



(h-2) OKY (L/H/x) = S1 S2 S3



**(i). "Edge-Loop + Level-Sequential" Function**

(i-1) OKY (x/U/R) = S1 S2 S3

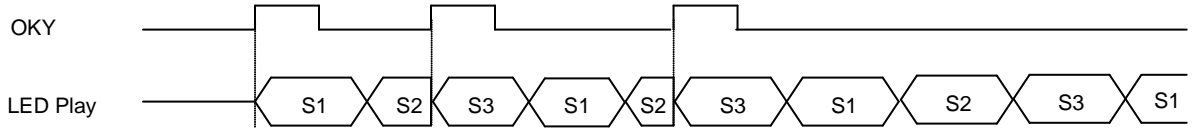

(i-2) OKY (x/U/R) = S1 S2 S3, Loop On/Off is enabled.

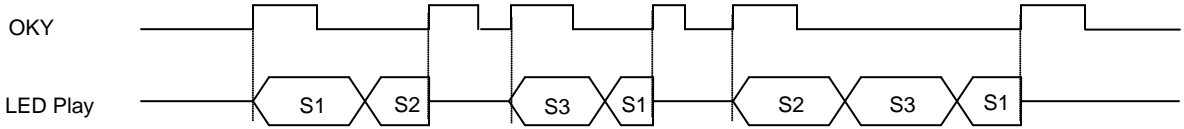

(i-3) OKY (x/U/R) = S1 S2 S3, Loop-End is enabled.

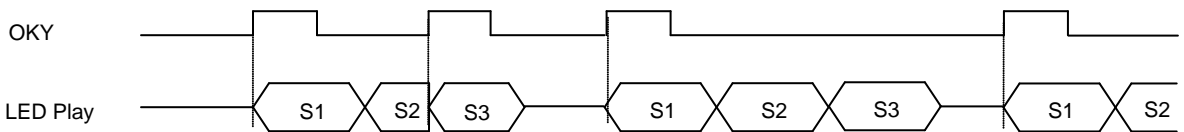

(i-4) OKY (x/U/R) = S1 S2 S3, Level-Stop is enabled.

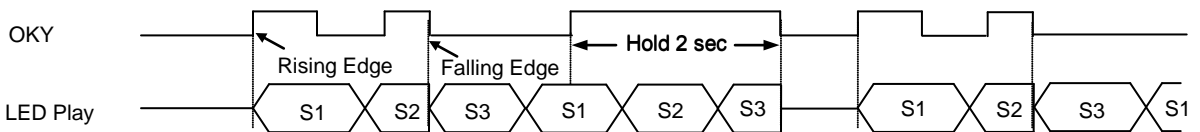

**(j). Pause-Resume Function**

(j-1) OKY (L/U/R) = S1 S2 S3, Level-Sequential is enabled.

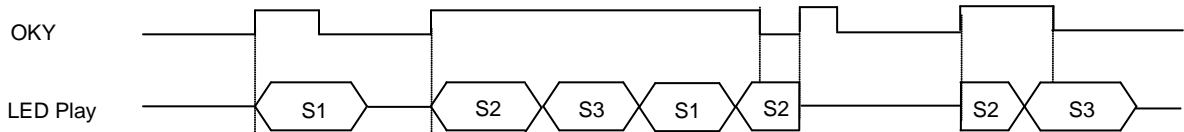

(j-2) OKY (x/U/R) = S1 S2 S3, "Edge-Loop + Level-Sequential" is enabled.

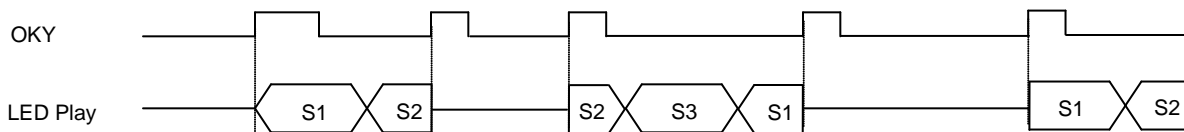

**(k) Serial-Trigger Function** (All inputs must be set as short debounce)

OKY (E/U/R) =S1 S2 S3 S4, IO1 (E/U/R) =S5 (OKY Reset is enabled, and S5 is a short mute Sentence)

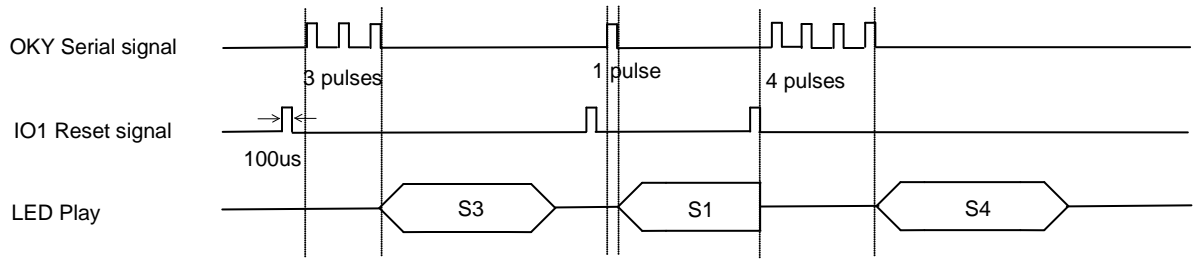

※ The pulse width must be longer than 50us (i.e. short debounce time), and users can set the typical **high pulse width as 100us**, **low pulse width 200us**.

※ The above is the simplest 2-wire control by external MCU. If necessary, user can use 3-wire control with Busy\_High output signal to do feedback.

**10. APPLICATION**

**(1) POP with 7 LEDs (3\*Sink and 4\*Drive)**

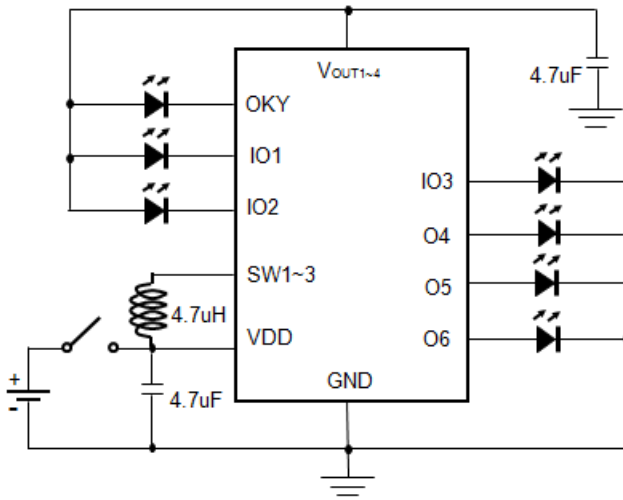

**(2) 1 Alone trigger with 6 LEDs (Sink)**

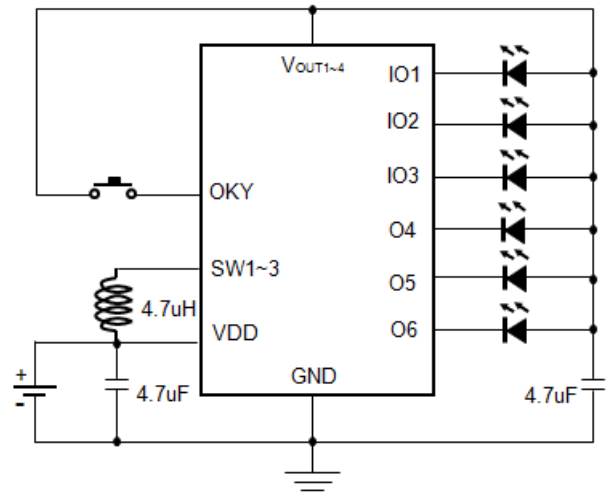

**(3) 2 Alone triggers with 5 LEDs (Sink)**

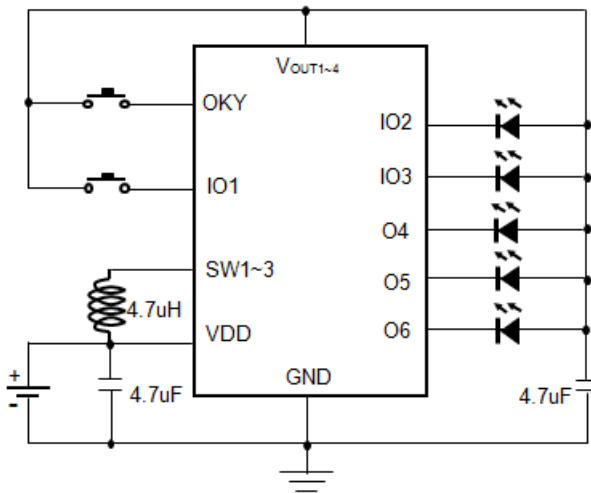

**(4) 1 Alone trigger and Mode Switch with 5 LEDs (Sink)**

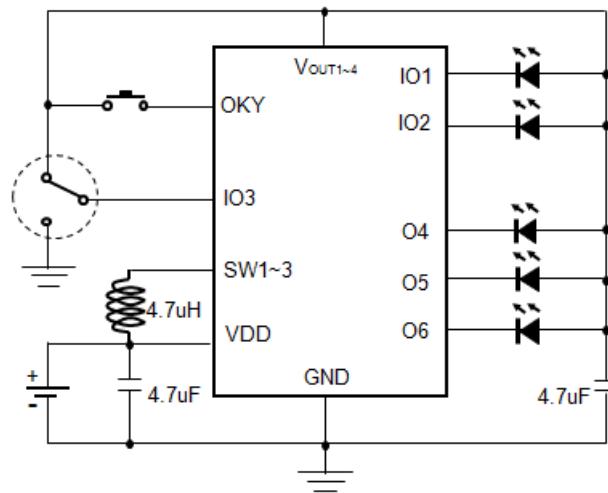

**11. DIE PAD DIAGRAM**

**11.1 NY1C007A**

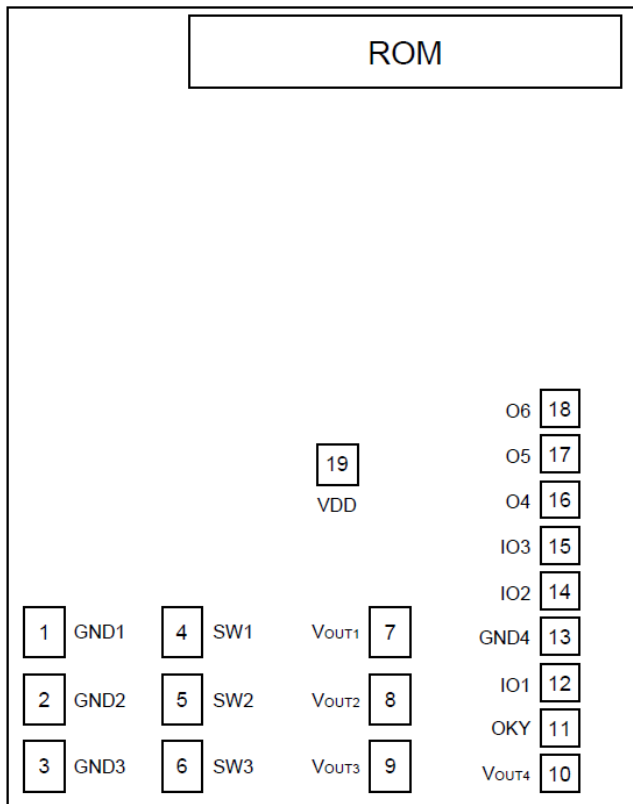

**12. PACKAGE DIMENSION**

**12.1 8-Pin Plastic SOP (150 mil)**

	INCHES			MILLIMETERS		
	MIN	TYP	MAX	MIN	TYP	MAX
A	0.183	-	0.202	4.65	-	5.13
B	0.144	0.150	0.163	3.66	3.81	4.14
C	0.068	-	0.074	1.35	-	1.88
D	0.010	-	0.020	0.25	-	0.51
F	0.015	-	0.035	0.38	-	0.89
G	0.050 BSC			1.27 BSC		
J	0.007	-	0.010	0.19	-	0.25
K	0.005	-	0.010	0.13	-	0.25
L	0.189	-	0.205	4.80	-	5.21
M	-	-	8°	-	-	8°
P	0.228	-	0.244	5.79	-	6.20

**Note: For 8-pin SOP IC, 100 units per tube.**

**13. ORDERING INFORMATION**

<i>P/N</i>	<i>Shipping Type</i>	<i>Remarks</i>
NY1C007A	Die	-
NY1C007AS8-xxx	SOP-8	Standard code, Width 150 mil