



九齊科技股份有限公司
Nyquest Technology Co., Ltd.

DATA SHEET

NY2A Series

2 I/O Dual-Tone or Speech Synthesizer

Version 1.2

Feb. 12, 2010

NYQUEST TECHNOLOGY CO. reserves the right to change this document without prior notice. Information provided by NYQUEST is believed to be accurate and reliable. However, NYQUEST makes no warranty for any errors which may appear in this document. Contact NYQUEST to obtain the latest version of device specifications before placing your orders. No responsibility is assumed by NYQUEST for any infringement of patent or other rights of third parties which may result from its use. In addition, NYQUEST products are not authorized for use as critical components in life support devices/systems or aviation devices/systems, where a malfunction or failure of the product may reasonably be expected to result in significant injury to the user, without the express written approval of NYQUEST.

Revision History

<i>Version</i>	<i>Date</i>	<i>Description</i>	<i>Modified Page</i>
1.0	2009/11/27	Formally release.	-
1.1	2009/12/31	7. Modify "Voltage Vs. Freq" figure.	11
1.2	2010/2/12	7. Modify "Output Current" value.	11

1. 概述

NY2A系列產品為單晶片CMOS音樂和語音合成 IC，只有1個母體 NY2A001A。具有1個Input腳和1個I/O腳，利用精準的內阻震盪故不需外加震盪電阻，內建一組PWM輸出，故無須再外加任何零件。音樂合成方式為可程式的方波和包絡線，語音合成方式為 4-bit Advanced LOG-PCM，藉由製造過程中更換Code光罩，可將不同的音樂語音資料寫入ROM中。用戶可使用簡便的 Q-Tone, Q-Melody 和 Quick-IO 工具軟體來快速地進行開發。

2. 功能

(1). 寬廣的工作電壓： 1.8V ~ 5.5V。

(2). 只有1個母體，音樂及語音共用一塊ROM，可支援的最大音樂音符或語音秒數(@6kHz)如下：

P/N	NY2A001
Note	Max. 1,344
Voice (sec)	Max. 0.9 sec

(3). 有2個I/O腳: OKY只能作為輸入腳， IO1可選擇作輸入腳或是輸出腳。(光罩選擇)

(4). 音樂和語音最多可被分割成最多32個語音音樂段(Voice/Melody Section)，每段長度可不同，每一語音音樂段中的語音音樂+靜音長度必須為 40H (Hex) 的整數倍。

(5). 最多有256個語音音樂格(Voice/Melody Step)，可規劃成32個語音音樂組(Voice/Melody Sentence)，OKY、IO1能分別指定 32、1 個語音音樂組(Sentence)。每一語音音樂格(Step)可指定任一個語音音樂段(Section)和 IO1 的輸出搭配(當IO1設為輸出時)。

(6). 語音和音樂不能同時輸出，只能選擇輸出一通道的語音或是兩通道的音樂，但是可以在語音音樂組中的語音音樂格分別填入語音段與音樂段，來實現在音樂的音符間隔中插入語音。

(7). 音樂最多為兩通道(Tone-1 & Tone-2)，每個通道可分別自訂一組可程式的音色音源(Patch)和包絡線(Envelope)。每個音色音源(Patch)可選擇為8段或16段的可程式方波，8段方波可支援到第7個Octave的音域，16段方波只支援到第6個Octave的音域，每段方波可分別定義成 0%， 25%， 50% 或 100% 的高度，不同的高度設定可以讓音色產生更多變化。每個包絡線(Envelope)有128階變化，不同的包絡線畫法也會讓音色產生不同的變化。

(8). 可支援音樂的拍子(Tempo)為25種： 234, 208, 188, 170, 156, 144, 134, 125, 117, 110, 104, 99, 94, 89, 85, 82, 78, 75, 72, 69, 67, 65, 63, 60, 59；可支援音樂的拍長(Beat)為7種: 4, 2, 1, 1/2, 1/4, 1/8, 1/16。另外提供拍長合成功能，可以用7種固定拍長來組合出任意長度的拍長，例如: 1 + 2 = 3, 1/2 + 1/4 = 3/4, 1/4 + 1/8 + 1/16 = 7/16, ...。合成後的拍長套用一個包絡線，且合成內的拍長可以指定相同或不同的音高和輸出。

(9). 只有內建一組準確的頻率振盪器(+/- 1.5% 誤差)，並無提供外部震盪電阻選項。共有16種不同播放速度可供選擇，每一個語音音樂格(Voice/Melody Step)可選擇不同的播放速度來使用。

1	2	3	4	5	6	7	8
12.0kHz	10.8kHz	9.7kHz	8.9kHz	8.0kHz	7.5kHz	7.0kHz	6.5kHz
9	10	11	12	13	14	15	16
6.1kHz	5.8kHz	5.4kHz	5.2kHz	4.9kHz	4.7kHz	4.5kHz	4.3kHz

(10). 輸入腳的輸入選項：(光罩選擇)

- (a). 任一輸入腳可分別選擇 Edge/Level, Hold/Unhold, Retrigger/Irretrigger 不同的觸發方式組合。
- (b). 任一輸入腳可分別選擇 CDS+1M、CDS、1M 的下拉電阻 或 Floating。(CDS+1M選項: 當按鍵按下時，IC內部為 1MΩ 的下拉電阻；而當按鍵放開時，IC內部為 300KΩ+1MΩ 並聯 的下拉電阻 約230KΩ。 CDS 選項: 當按鍵按下時，IC內部為 Floating ；而當按鍵放開時，IC內部為 300KΩ 的下拉電阻。)
- (c). 任一輸入腳可分別選擇Debounce時間：Long - 提供一般按鍵使用；Short - 提供彈跳開關使用。
- (d). OKY輸入腳最多有32個Sentence的One-Key Sequential 或 Random 的選擇，在 One-Key Sequential 時 並可選擇Sentence的播放順序在其他按鍵被觸發後是否要Reset。
- (e). 只有一個輸入腳可選擇是否有 Toggle On/Off 的功能 (1st 觸發 → 播放，2nd 觸發 → 停止，.....)。

※ 注意: 按鍵輸入的優先順序為 OKY1 > IO1。

(11). 所有的輸出腳都可提供大電流來直推高亮度LED。(I_{ol}=20mA @V_{DD}=3V)

(12). 所有的輸出腳都有以下 12 種輸出選項：(光罩選擇)

- (a). Stop_Low pulse：停止播放時送出低位準脈衝。
- (b). Stop_High pulse：停止播放時送出高位準脈衝。
- (c). Busy_High active：播放時送出高位準訊號。(Drive輸出)
- (d). Busy_Low active：播放時送出低位準訊號。(Sink輸出)
- (e). LED 2Hz flash：播放時 LED 2Hz Drive或Sink輸出閃爍。
- (f). LED 4Hz flash：播放時 LED 4Hz Drive或Sink輸出閃爍。
- (g). LED 8Hz flash：播放時 LED 8Hz Drive或Sink輸出閃爍。
- (h). LED 16Hz flash：播放時 LED 16Hz Drive或Sink輸出閃爍。
- (i). LED dynamic 1/2：播放時 LED根據1/2聲音位準做Drive或Sink輸出動態閃爍。
- (j). LED dynamic 3/4：播放時 LED根據3/4聲音位準做Drive或Sink輸出動態閃爍。
- (k). QIO訊號: 可隨語音作任意的輸出變化，每一個語音格(Step)可選擇一組QIO訊號，用戶使用此功能需先開啓Quick-IO編輯器來做QIO訊號編輯。
- (l). QLED訊號: 可隨音樂作輸出的變化，每一個音符都可選擇一種QLED訊號，用戶使用此功能需先開啓音樂編輯器(Cakewalk)來做QLED訊號編輯。QLED訊號有8種狀態可供選擇：根據包絡線時間長度來漸明、根據包絡線時間長度來漸暗、根據包絡線閃一下、根據音符閃一下、亮度為0%(全暗)、亮度為33%(1/3亮度)、亮度為66%(2/3亮度)、亮度為100%(全亮)。(IO1隨Tone-1 音符音符做變化)

※ 注意: LED 2Hz / 4Hz / 8Hz / 16Hz flash 是指以 8kHz 的播放速度 時LED閃爍的頻率；不同的播放速度，LED閃爍的頻率也會不同。但當播放音樂時，LED閃爍固定為 2Hz / 4Hz / 8Hz / 16Hz flash。

(13). 特殊功能選項 "上電播放" (Power-On-Play, POP)：電池一上電立即播放一次"上電播放語音音樂組"(POP Sentence)，觸發模式固定為 Edge / Unhold / Retrigger。如果結合Power-On-Loop功能，則該語音音樂組會一直循環播放，直到其他按鍵被觸發才會停止，並立即播放觸發按鍵所指定的語音音樂組。

(14). 特殊功能選項 "短觸發循環播放" (Edge-Loop)：當OKY按鍵一被觸發，該觸發按鍵所指定的語音音樂組會一直循環播放。如果結合 One-Key Sequential 功能，再次觸發該按鍵，會循環播放下一個語音音樂組。如果結合 Loop On/Off 功能，再觸發該按鍵，聲音會停止，再次觸發則循環播放下一個語音音樂組。

※ 注意: Loop On/Off 與 Toggle On/Off 不能同時存在。

(15). 特殊功能選項 "長觸發順序循環播放" (Level-Sequential) : 當OKY按鍵被觸發後持續按著, 會依序播放OKY所指定的語音音樂組, 一直循環播放 (S1, S2, S3, S1, S2, S3,), 按鍵離開則聲音立即停止(Hold mode) 或播完該語音音樂組後停止(Unhold mode), 再按著按鍵則播放下一個語音音樂組, 然後仍然依序循環播放。如果結合Edge-Loop功能, OKY按鍵被觸發後(不需持續按著), 會依序播放OKY所指定的語音音樂組, 一直循環播放, 再次觸發該按鍵, 會立即播放下一個語音音樂組, 然後仍然依序循環。如果結合Edge-Loop 和 Loop On/Off 功能, 再次觸發該按鍵, 聲音會停止, 再觸發則播放下一個語音音樂組, 然後仍然依序循環播放。

(16). 特殊功能選項 "選曲功能" (Voice-Select) : 此時OKY為選曲鍵, IO1為播放鍵; 先用OKY來依序選擇語音音樂組, 當IO1按鍵一被觸發, 則會播放OKY所選擇的語音音樂組。(此功能常見於門鈴的應用)

(17). 特殊功能選項 "鬧鐘/貪睡功能" (Alarm/Snooze) : 此時IO1為鬧鐘開關, OKY可設為貪睡按鍵。當IO1開關在開啓狀態時, 如果鬧鐘時間到達, 會先播放IO1所指定的語音音樂組一次, 然後接著循環播放特定的"循環語音音樂組"(Loop Sentence), 直到鬧鐘時間結束; 在鬧鈴聲音播放時, 如果關閉IO1開關, 則停止播放鬧鈴聲音, 並播放一次特定的"跳躍語音音樂組"(Jump Sentence); 在鬧鈴聲音播放時, 如果按一下貪睡鍵, 則停止播放, 並依照貪睡按鍵所設定的貪睡時間來等待, 直到貪睡時間結束, 接著會循環播放特定的"循環語音音樂組"(Loop Sentence)。

※ 注意: Loop Sentence 和 POP Sentence 共用同一個語音音樂組。

(18). 特殊功能選項 "內部觸發" (Internal-Feedback) : 當OKY或IO1的聲音停止播放或播放結束時, 利用內部的 Stop_High-Pulse信號來自動觸發OKY或IO1所指定的語音音樂組(Internal-Feedback Path), 播放該語音音樂組一次。

※ 注意: 當啓動此功能時, IO1只能當做輸入腳。

(19). 特殊功能選項 "雜訊觸發" (Noise-Trigger) : 當選擇此功能時, OKY被設定為 Edge/Unhold 功能, 應用時需將OKY輸入在PCB的Layout做成較長的輸入線, 當外部有較大的雜訊產生時, 利用天線效應的原理來產生輸入訊號, OKY外部懸空不需連接到VDD或GND腳。(此功能常見於電子打火機和手機天線的應用)

(20). 一組PWM輸出, 有兩種PWM音量可供選擇(正常音量&大音量), 可直接驅動8Ω、16Ω、32Ω、64Ω的喇叭或蜂鳴片。

(21). 低壓復位(LVR), 當電壓瞬間低於1.8V時, IC 會自動復位。(光罩選擇)

(要進一步了解上述功能, 請參考Q-Tone的使用手冊, 或聯繫九齊科技或九齊代理商。)

1. GENERAL DESCRIPTION

The NY2A series are single-chip dual-tone melody or 1-ch voice synthesizing CMOS IC. There only is one body: NY2A001A. The IC body has one input and one I/O pins. Through the accurate internal oscillation of built-in Rosc and one built-in PWM output, thus any external component is not required. Using programmable patch and envelop of melody and 4-bit Advanced LOG-PCM algorithm of voice, customer's melody and voice data can be programmed into ROM by changing one code mask during fabrication. Besides, the interactive software developing tools of "Q-Tone", "Q-Melody" & "Quick-IO" are user-friendly and quick for programming.

2. FEATURES

- (1). Wide operating voltage: 1.8V ~ 5.5V.
- (2). There is one body. The ROM data is shared by dual-tone melody and voice together. The maximum number of dual-tone notes or voice duration @6kHz are as following.

P/N	NY2A001
Note	Max. 1,344
Voice (sec)	Max. 0.9 s

- (3). Two I/O pins: OKY can only be input pin. IO1 can be either input or output pin (Mask option).
- (4). The total melody and voice duration can be partitioned up to maximum 32 *Voice/Melody Sections*. Each *Voice/Melody Section* length is flexible. The *Voice/Melody Section* length of "voice/melody length + mute length" must be the multiple of 40H (Hex).
- (5). Total maximum 256 *Voice/Melody Steps* are available for 32 *Voice/Melody Sentences*. OKY and IO1 input can assign 32 and 1 *Sentences* independently. Each *Step* can specify one *Voice/Melody Section* and enable/disable IO1 output option if IO1 is set as output.
- (6). Dual-Tone melody and voice can't be played simultaneously. Meanwhile either melody or voice can be played only. User can fill out different Voice Section and Melody Section into Steps of one Sentence to achieve voice playing among melody notes.
- (7). There are maximum two channels of Tone-1 and Tone-2 for melody. Each channel can assign one set of programmable patch and envelope. Each patch can be one of 8-step or 16-step programmable square waveform. The 8-step patch can support the pitch range up to the 7th octave, and other 16-step patch can support up to the 6th octave. There are 4-level altitudes of 0%, 25%, 50% and 100% for each square step. Through level change of different altitude, the timbre will be much of variety. In addition, there are 128-level altitudes for each envelope, and it can make timbre more various.
- (8). There are 25 kinds of tempo: 234, 208, 188, 170, 156, 144, 134, 125, 117, 110, 104, 99, 94, 89, 85, 82, 78, 75, 72, 69, 67, 65, 63, 60, 59. And there are 7 kinds of beat: 4, 2, 1, 1/2, 1/4, 1/8, 1/16. Besides, a beat synthesizing function is provided to synthesize arbitrary beat. For examples, 1 + 2 = 3, 1/2 + 1/4 = 3/4, 1/4 + 1/8 + 1/16 = 7/16, The synthesized beat imitates the original envelope, and the synthesizing beats can assign the same or different pitch and output option.

- (9). Only build in an accurate internal oscillator of +/- 1.5% tolerance, no external R oscillator. There are 16 kinds of options for play speed, and each *Step* can select any one of them independently.

1	2	3	4	5	6	7	8
12.0kHz	10.8kHz	9.7kHz	8.9kHz	8.0kHz	7.5kHz	7.0kHz	6.5kHz
9	10	11	12	13	14	15	16
6.1kHz	5.8kHz	5.4kHz	5.2kHz	4.9kHz	4.7kHz	4.5kHz	4.3kHz

- (10). Input option for input pin. (Mask option)

- (a). Each input can select Edge/Level, Hold/Unhold and Retrigger/Irrittrigger trigger modes.
- (b). Each input can select CDS+1M, CDS, 1M pull-low resistor or Floating type.
(CDS+1M option: Only 1MΩ pull-low resistance at key-pressed, and 300KΩ+1MΩ in parallel pull-low resistance around 230KΩ at key-released. CDS option: Floating at key-pressed, and 300KΩ pull-low resistance at key-released.)
- (c). Each input can select Debounce time: Long debounce for push-button. Short debounce for fast switch.
- (d). OKY input can select One-Key Sequential or Random for maximum 32 *Sentences* independently. At One-Key Sequential, the Reset function of playing *Sentence* sequence can be enabled or disabled when other keys are triggered.
- (e). Only one input pin can select Toggle On/Off function (1st Trigger → play, 2nd trigger → stop,).

※ *Note: Input priority is OKY > IO1.*

- (11). All output pins support large-current output and can directly drive high brightness LED. ($I_{ol}=20mA@V_{DD}=3V$)

- (12). There are 12 kinds of output option for all output pins. (Mask option)

- (a). Stop_Low pulse: Low active stop-pulse output whenever device stop playing.
- (b). Stop_High pulse: high active stop-pulse output whenever device stop playing.
- (c). Busy_High active: high active signal output during playing. (Drive output)
- (d). Busy_Low active: low active signal output during playing. (Sink output)
- (e). LED 2Hz flash: 2Hz Sink or Drive signal output to drive LED during playing.
- (f). LED 4Hz flash: 4Hz Sink or Drive signal output to drive LED during playing.
- (g). LED 8Hz flash: 8Hz Sink or Drive signal output to drive LED during playing.
- (h). LED 16Hz flash: 16Hz Sink or Drive signal output to drive LED during playing.
- (i). LED dynamic 1/2: according to 1/2 sound level, dynamic Sink or Drive signal output to drive LED.
- (j). LED dynamic 3/4: according to 3/4 sound level, dynamic Sink or Drive signal output to drive LED.
- (k). QIO signal: arbitrary output with voice. Each *Voice Step* can select one set of QIO signal and user can edit the QIO signal by “Quick-IO” editor.
- (l). QLED signal: output with melody. Each note can select one kind of QLED signal and user can edit the QLED signal by “Q-Melody” or by Midi editor such like *Cakewalk*. There are 8 kinds of QLED signal: Ascend by envelope length, Descend by envelope length, Flash once by envelope, Flash once by note, 0% brightness (Off), 33% brightness (1/3), 66% brightness (2/3), 100% brightness (On). (*IO1 vary with Tone-1 note.*)

※ Note: Where (e) ~ (h) is the LED flash rate at 8kHz sample rate. For different play speed, the LED flash rate is different from original 2Hz, 4Hz, 8Hz or 16Hz. While playing melody, the LED flash rate is fixed as 2Hz, 4Hz, 8Hz or 16Hz up to the output option.

(13). “Power-On-Play” special function (POP): When power is on, play the POP Sentence one time. The trigger mode is fixed as Edge / Unhold / Retrigger. To cooperate with Power-On-Loop function, the POP Sentence will be played in loop until other key-trigger happened. When other key is triggered, it stops playing the POP Sentence and immediately plays the assigned sentence of triggered key.

(14). “Edge-Loop” special function: When OKY is triggered, playing the assigned sentence in loop. To cooperate with One-Key Sequential function, playing the next assigned sentence in loop once key is triggered again. To cooperate with Loop On/Off function, stop playing if trigger once more, and play the next assigned sentence in loop once key is triggered again.

※ Note: Loop On/Off and Toggle On/Off cannot be optioned together.

(15). “Level-Sequential” special function: When OKY is triggered and held, playing the assigned sentences sequentially in loop (S1, S2, S3, S1, S2, S3, ...), and stop playing at Hold mode or playback the sentence at Unhold mode after key is released. Holding key again to play the next sentences sequentially in loop as usual. To cooperate with Edge-Loop function, playing the assigned sentences sequentially in loop when OKY is triggered and not held. Trigger once more to play the next sentences sequentially in loop as usual. To cooperate with both Edge-Loop and Loop On/Off function, stop playing if trigger once more, and play the next sentences sequentially in loop once key is triggered again.

(16). “Voice-Select” special function: OKY is set as a select key to pick the desired sentence, and IO1 is set as a play key to play this selected sentence. When a desired sentence is selected through OKY sequential playing, to trigger IO1 will play this sentence. It’s popular in doorbell application.

(17). “Alarm/Snooze” special function: IO1 is set as an alarm clock switch to play alarm, and OKY is set as a snooze button. When IO1 alarm switch is turned on and alarm time is up, play the IO1 sentence one time and then play the “Loop Sentence” in loop until alarm period is over. Once turn off alarm switch while alarm playing, stop alarm playing and then play the “Jump sentence” one time. Once press the snooze button while alarm playing, stop alarm playing and then wait for one period of snooze time. After snooze is over, the “Loop Sentence” will be played in loop.

※ Note: Loop Sentence and POP Sentence share the same sentence.

(18). “Internal-Feedback” special function: When the playing sentence of OKY or IO1 is stopped or over, continue to play the assigned sentence of OKY or IO1 through internal Stop_High-Pulse signal (Internal-Feedback Path).

※ Note: When enable this function, IO1 is fixed as input pin.

(19). “Noise-Trigger” special function: When this function is selected, OKY is set as Edge/Unhold function. In PCB layout, OKY input needs a longer input line. By antenna effect, it takes place an input signal when larger noise happens outside. OKY is floating externally and is not necessary to connect to VDD or GND. It’s popular in electric lighter or mobile antenna application.

(20). There are 2 kinds of PWM output, normal and large. It can directly drive 8, 16, 32, 64Ω speaker or piezo-buzzer.

(21). Low-Voltage-Reset (LVR). When voltage is lower than 1.8V, IC will reset by itself. (Mask Option)

(For details of the above functions, please refer to Q-Tone user manual, or contact Nyquest or her agents.)

3. BLOCK DIAGRAM

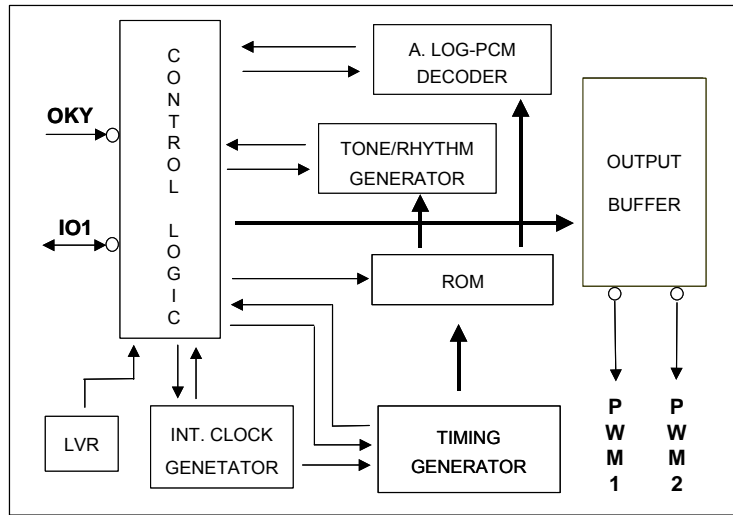

4. PAD DESCRIPTION

Pad Name	Pad No.	ATTR.	Description
OKY	1	I	Input pin, active high.
IO1	2	I/O	Output or input pin. To be input, active high.
GND	3	Power	Negative power.
VDD	4	Power	Positive power.
PWM1	5	O	PWM output 1.
PWM2	6	O	PWM output 2.

5. DEVELOPMENT & DEMONSTRATION

User can use “Q-Tone” & “Quick-IO” software tools to develop the desired functions. After finishing the code programming, user will get 2 files of “.bin” and “.htm”, the binary file and function check list. Through “FDB_Writer” operation, user can download the “.bin” file into NY2_FDB flash demo board to demonstrate the NY2A function. Once the function has been approved, user only need to send the “.bin” file to Nyquest for code release. For more details, please refer to “Q-Tone” & “Quick-IO” user manual.

2Mb Flash Demo board	NY2_FDB-02
Max. demo body	NY2A001A

6. ABSOLUTE MAXIMUM RATING

Symbol	Rating	Unit
VDD~GND	-0.5 ~ +7.0	V
V _{in}	GND-0.3 < V _{in} < VDD+0.3	V
V _{out}	GND < V _{out} < VDD	V
T _{op} (operating)	-0 ~ +70	°C
T _{st} (storage)	-55 ~ +150	°C

7. DC CHARACTERISTICS

Symbol	Parameter	Min.	Typ.	Max.	Unit	Condition
VDD	Operating voltage	1.8	3.0	5.5	V	
I _{sb}	Standby current, V _{DD} =3V/4.5V		0.05	0.1	uA	No loading
I _{op}	Operating current	V _{DD} =3V	500			
		V _{DD} =4.5V	1500			
I _{ih}	Input current (1M ohms pull-low)		3		uA	V _{DD} =3V
			10			V _{DD} =4.5V
I _{oh}	Output drive current		-7		mA	V _{DD} =3V, V _{oh} =2.0V
			-11			V _{DD} =4.5V, V _{oh} =3.5V
I _{ol}	Output sink current		20		mA	V _{DD} =3V, V _{ol} =1.0V
			30			V _{DD} =4.5V, V _{ol} =1.0V
I _{oh}	PWM1, PWM2 output current (Normal)		-65		mA	V _{DD} =3V, V _{oh} =1.5V
I _{ol}			65			V _{DD} =3V, V _{ol} =1.5V
I _{oh}	PWM1, PWM2 output current (Large)		-75		mA	V _{DD} =3V, V _{oh} =1.5V
I _{ol}			75			V _{DD} =3V, V _{ol} =1.5V
ΔF/F	Frequency deviation by voltage drop	V _{DD} =3V		-0.5	%	$\frac{F_{osc}(3.0v)-F_{osc}(2.4v)}{F_{osc}(3v)}$
		V _{DD} =4.5V		-1		$\frac{F_{osc}(4.5v)-F_{osc}(3.0v)}{F_{osc}(4.5v)}$
ΔF/F	Frequency lot deviation, (V _{DD} =3V)	-1.5		1.5	%	$\frac{F_{max}(3.0v)-F_{min}(3.0v)}{F_{max}(3.0v)}$
F _{osc}	Oscillation Frequency	1.23	1.54	1.65	MHz	V _{DD} =1.8~5.5V

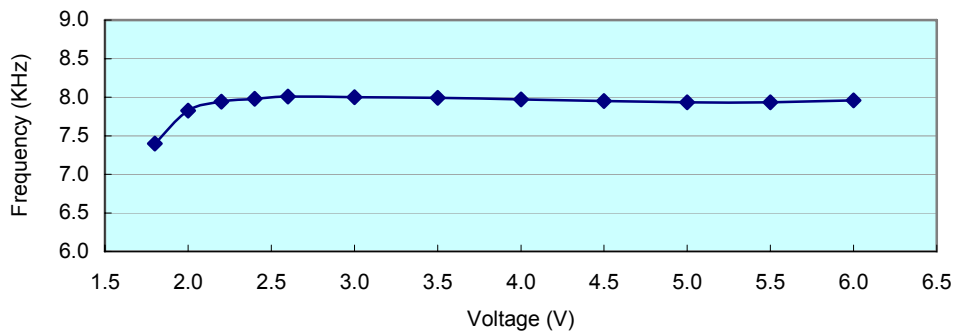
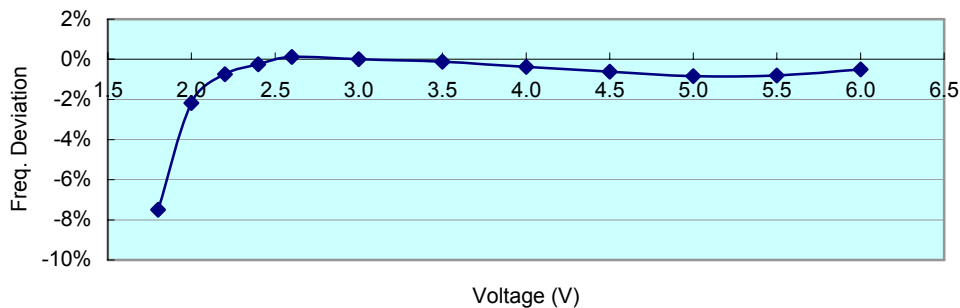
Voltage vs Frequency (SR=8.0KHz@3V)

Voltage vs Freq. Deviation (SR=8.0KHz@3V)

8. TIMING DIAGRAM

(1) Debounce Time

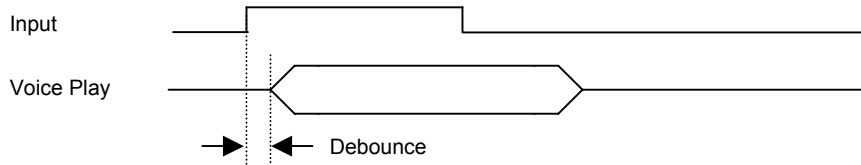
(a). Trigger while no playing voice



※ Debounce time is configured by 6 kHz S.R and the value is fixed. That is, Long debounce = 20ms, Short debounce = 50us

(b). Trigger While playing voice

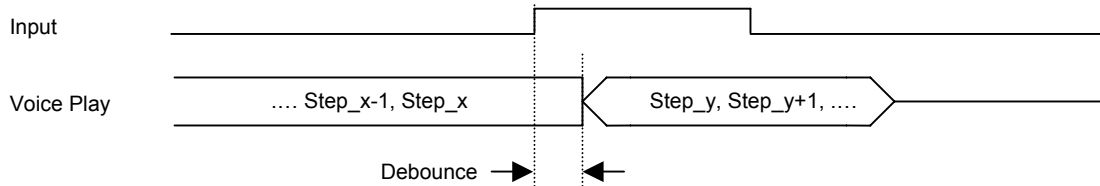

※ Debounce Time is configured by the S.R. of Step_x. At S.R. = 6kHz, Long debounce = 20ms, Short debounce = 50us

For example, if Step_x S.R. = 8kHz, Long debounce = $20ms * (6k/8k) = 15ms$, Short debounce = $50us * (6k/8k) = 37.5us$

(2) Input Priority

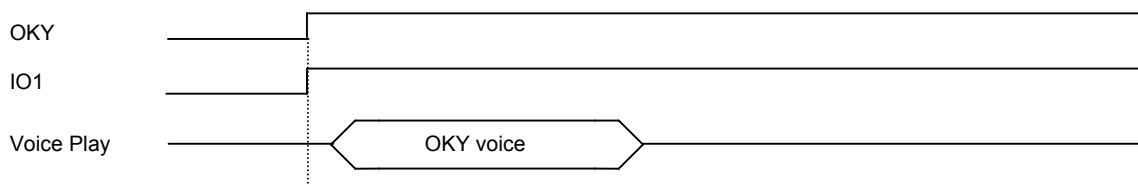

※ Priority: OKY > IO1 > POP(Power-On-Play)

(3) Output Signal (IO1)

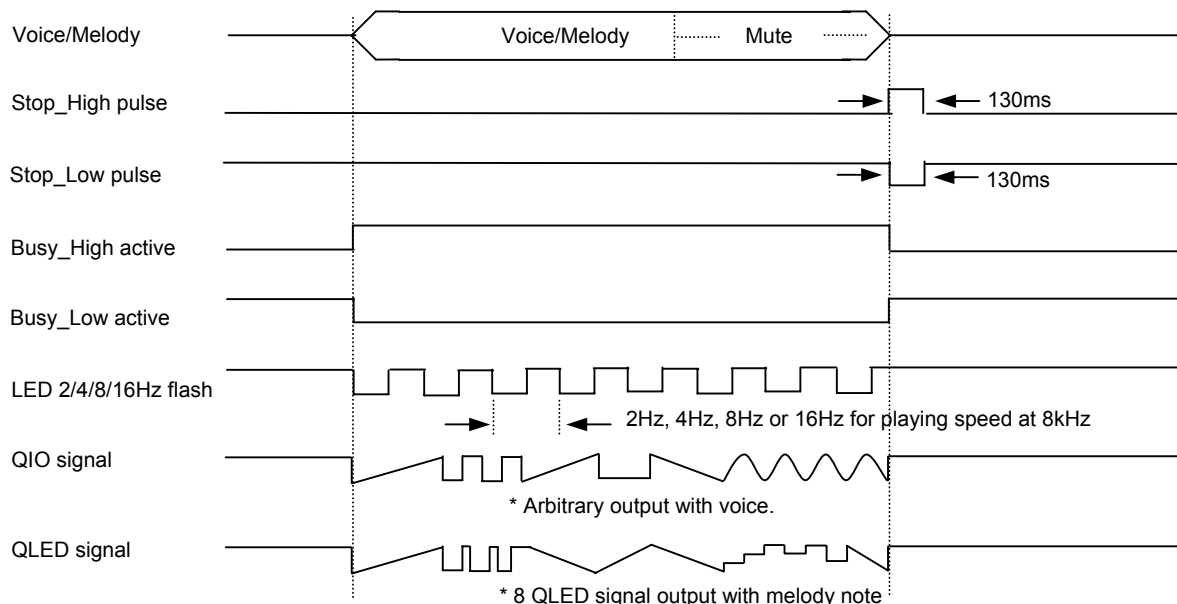

LED dynamic 1/2 or 3/4: When the voice amplitude is higher than 1/2 or 3/4 level, LED will be ON, e.g. output signal is low at sink mode.

(4) Basic Operation

(a). Edge mode, Edge trigger

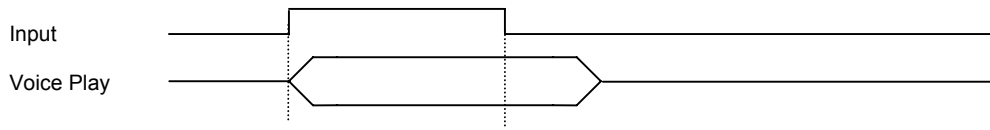

(b). Edge mode, Level trigger

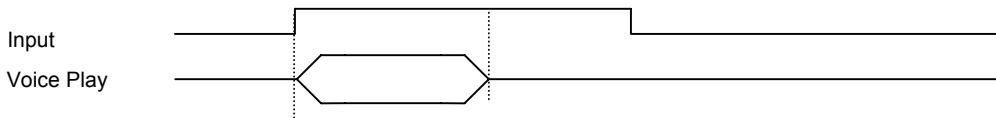

(c). Level mode, Edge trigger

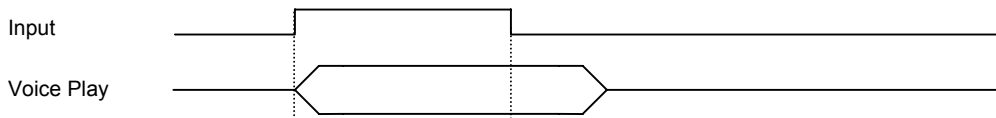

(d). Level mode, Level trigger

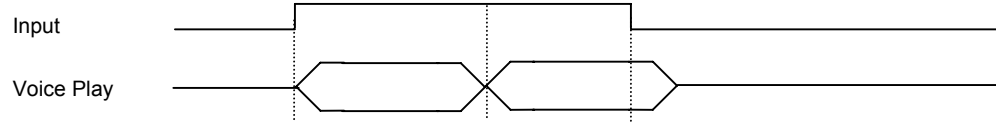

(e). Retrigger mode

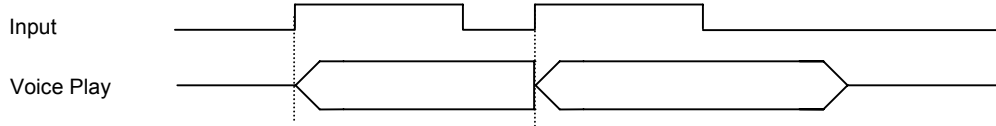

(f). Irretrigger mode

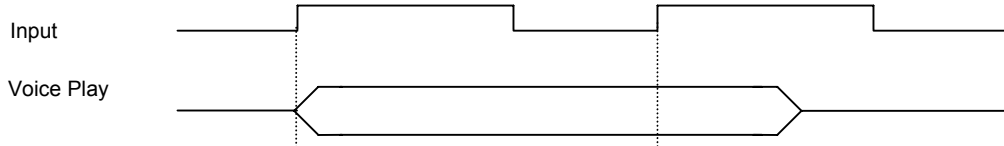

(g). Retrigger mode, first key priority

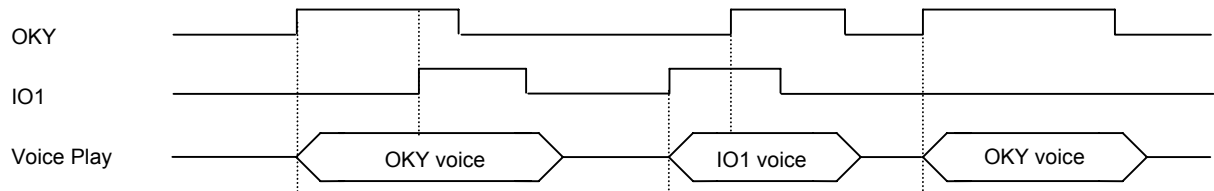

(5) Advanced Operation

(a). Different Input Reload (OKY is in Sequential mode)

(a-1) OKY (E/U/R) = S1 S2 S3 S4, IO1(E/U/R) = S5 (S1 means Sentence 1)

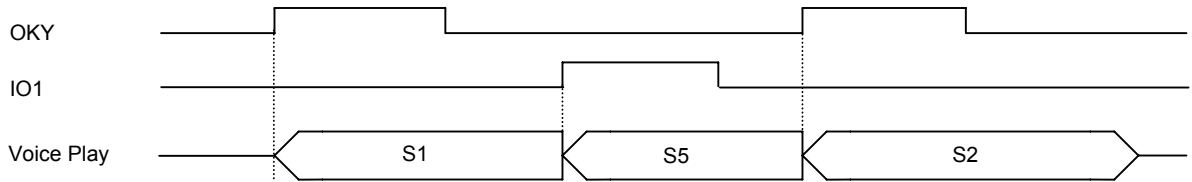

(a-2) OKY (E/U/R) = S1 S2 S3 S4, IO1 (L/x/x) = S5

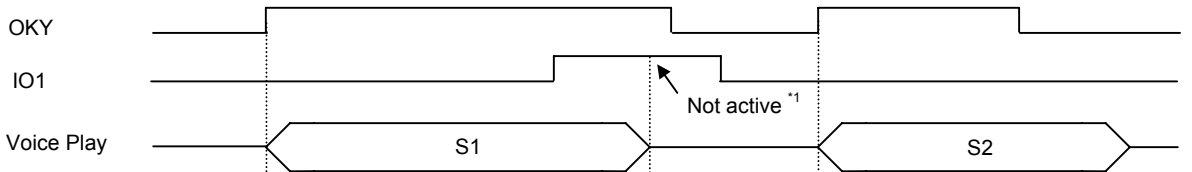

*1: If you press IO1 during OKY voice playing, at the moment of S1 end, the trigger mode follows OKY

(a-3) OKY (E/U/I) = S1 S2 S3 S4, IO1 (E/x/x) = S5

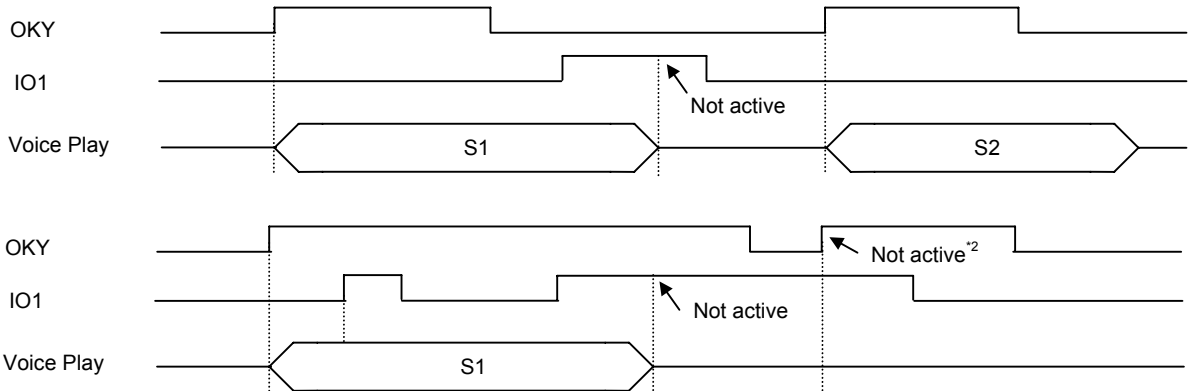

*2: Because IO1 signal is still high, in the same time IC can't accept the OKY Edge signal.

(a-4) OKY (E/U/I) = S1 S2 S3 S4, IO1 (L/x/x) = S5

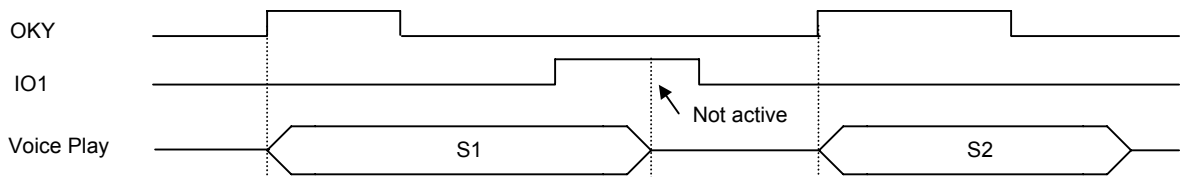

(a-5) OKY (L/U/x) = S1 S2 S3 S4, IO1 (E/x/x) = S5

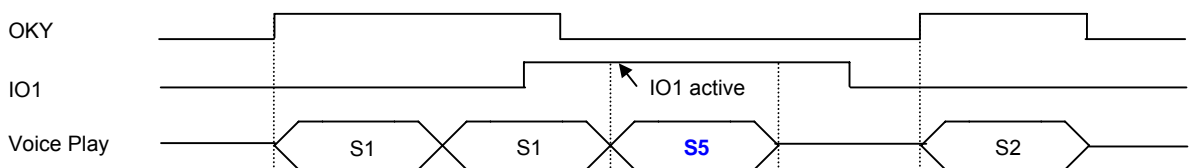

※ In the time of Sentence end: When S1 end, the trigger mode follows OKY (L/U/x). When S5 end, it follows IO1 (E/x/x).

※ Once S5 is played (just leave S1 ending), the trigger mode follows IO1 (E/x/x) immediately.

(a-6) OKY (L/U/x) = S1 S2 S3 S4, IO1 (L/U/I) =S5

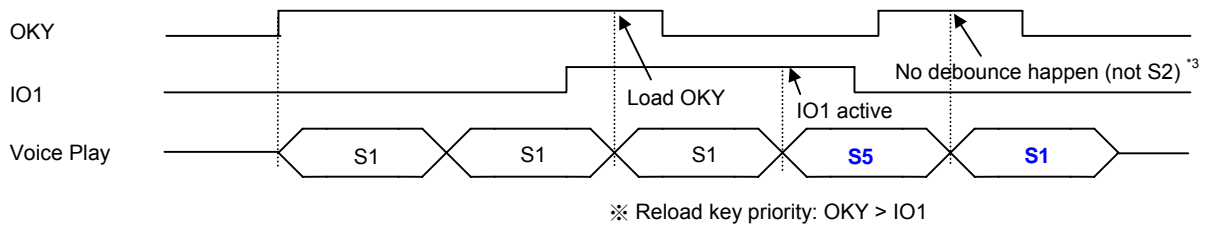

*3: In OKY mode, Sequential number is counted only if there is debounce happened.

(a-7) OKY (L/U/x) = S1 S2 S3 S4, IO1 (L/U/x) =S5

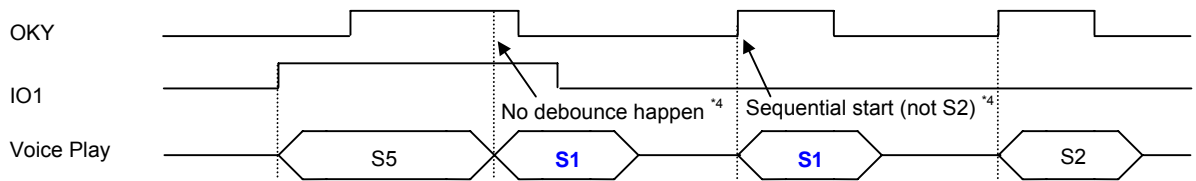

*4: In OKY mode, 1st trigger without debounce and Sequential number is still "1". 2nd trigger with debounce, after trigger the Sequential number become "2".

(b). Random Function

(b-1) OKY (L/U/I) =S1 S2 S3 S4, IO1 (L/U/I) =S5

Random (or Sequential) number is counted during "debounce time" or "key released time". But the first-time trigger only relies on "debounce time" due to no "key release time".

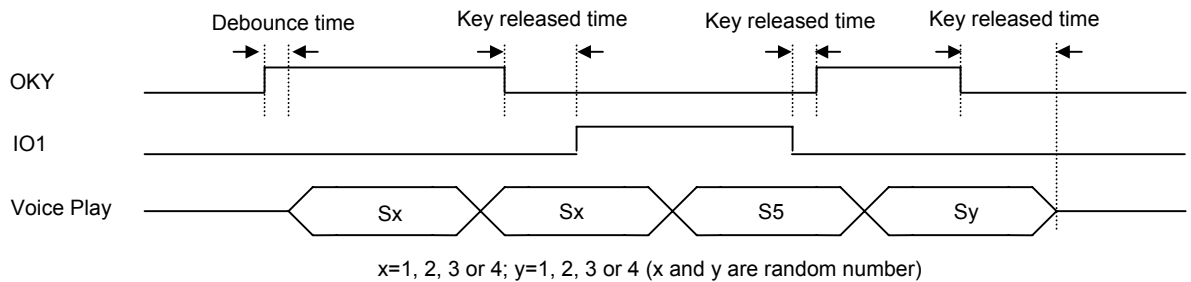

(b-2) OKY (L/U/R) =S1 S2 S3 S4, IO1 (L/U/R) =S5

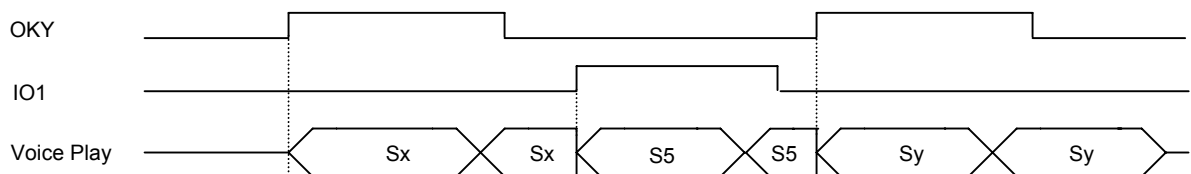

(c). Toggle On/Off Function

(c-1) OKY (E/U/R) = S1 S2 S3 S4, IO1 (E/U/R) = S5 (OKY is Sequential mode *without Reset*)

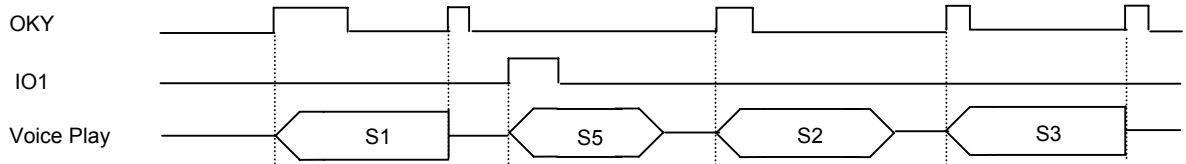

(c-2) OKY (E/U/R) = S1 S2 S3 S4, IO1 (E/U/R) = S5 (OKY is Sequential mode *with Reset*)

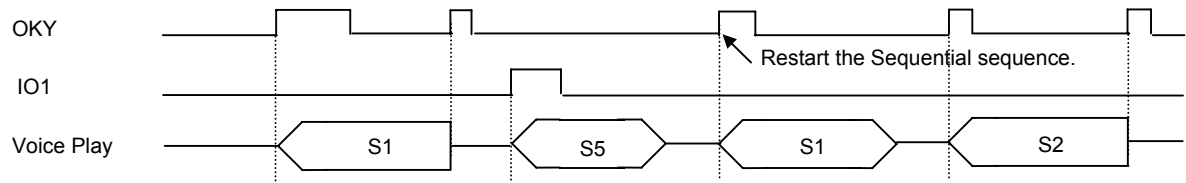

※ When OKY Sequential counter is going, to trigger other inputs will reset OKY Sequential sequence.

(d). External Feedback Function (IO1 is output and connected to OKY input)

(d-1) OKY (L/U/I) = S1 S2 S3 S4, IO1 = Stop_high pulse (When voice ends, IO1 shows a high pulse.)

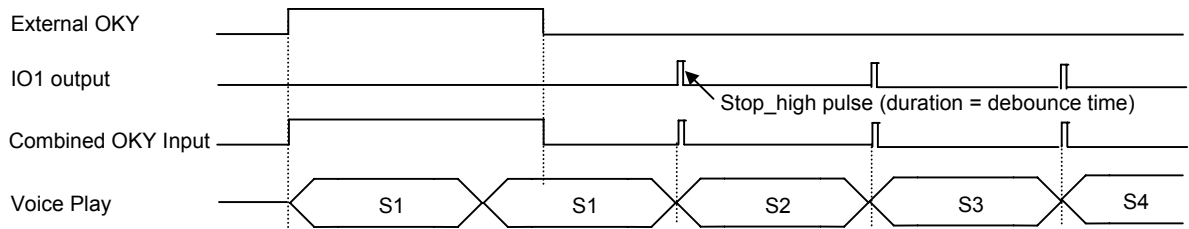

※ Originally the duration of Stop_high pulse is 130ms, but the high signal will trigger voice and turn low after debounce.

(d-2) OKY (E/U/I) = S1 S2 S3 S4, IO1 = Busy_low (When not playing voice, IO1 is high.)

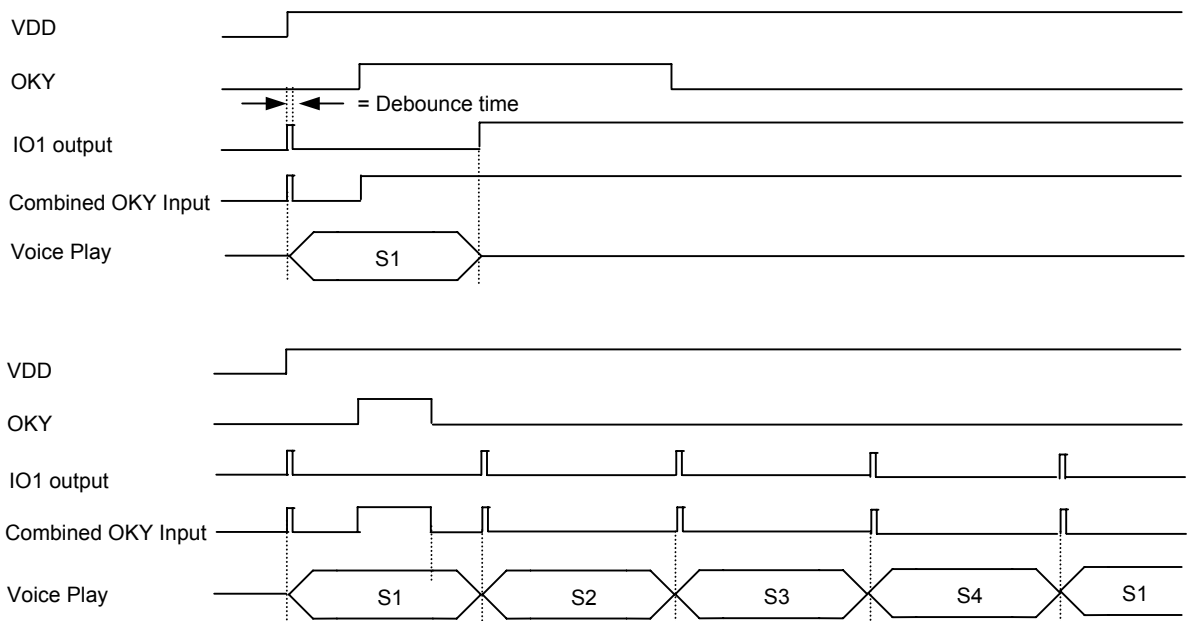

※ When power on, IO1 will generate a high pulse at Busy_low status and the duration is equal to debounce time.

(e). Internal-Feedback Function (IO1 is fixed as input)

Each sentence can assign an Internal-Feedback Path to play a fixed sentence after IO's sentence stop.

(e-1) OKY (L/U/I) = S1 S2 S3 S4, IO1 = S5, Internal-Feedback Path = IO1

If S1 is optioned with Internal-Feedback Path,

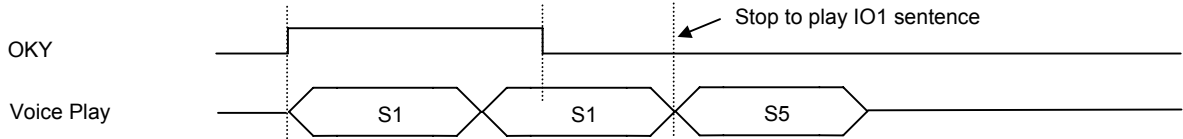

(e-2) OKY (L/H/I) = S1 S2 S3 S4, IO1 (x/x/R) = S5, Internal-Feedback Path = IO1

If both S1 and S5 are optioned with Internal-Feedback Path,

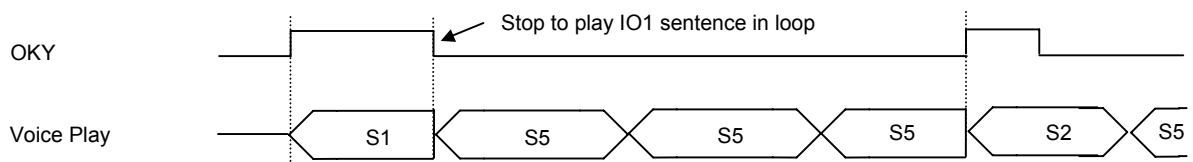

(f). Power-On-Play (POP) Function

The trigger mode of Power-On-Play is fixed as E/U/R, other trigger signal will stop POP's voice immediately and play the interrupted trigger's voice. POP can cooperate with Power-On-Loop function to play POP Sentence in loop.

(f-1) OKY (E/U/I) = S1 S2 S3 S4, POP (E/U/R) = S5

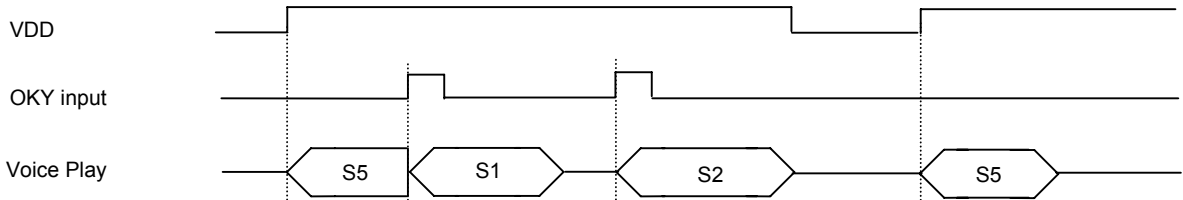

(f-2) OKY (E/U/I) = S1 S2 S3 S4, POP (E/U/R) = S5, Power-On-Loop is enabled.

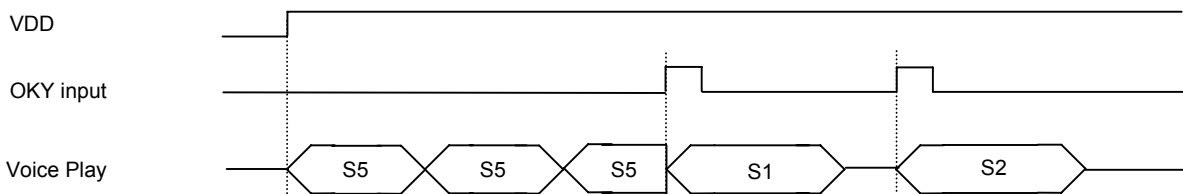

(g). Edge-Loop Function

(g-1) OKY (E/U/R) = S1 S2 S3

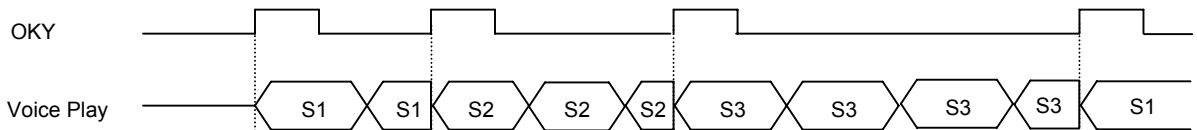

(g-2) OKY (E/U/R) = S1

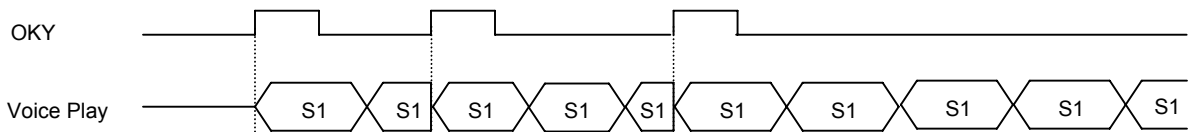

(g-3) OKY (E/U/R) = S1 S2 S3, Loop On/Off is enabled.

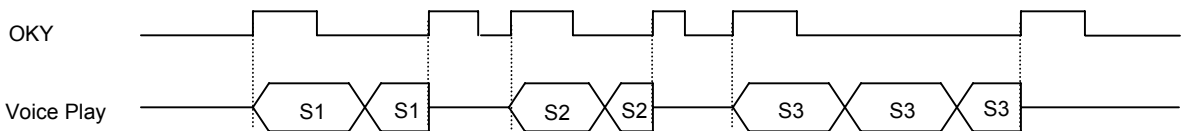

(h). Level-Sequential Function

(h-1) OKY (L/U/R) = S1 S2 S3

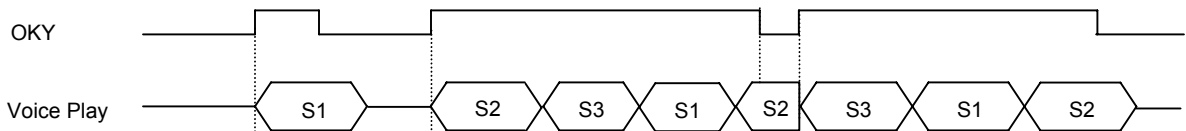

(h-2) OKY (L/H/x) = S1 S2 S3

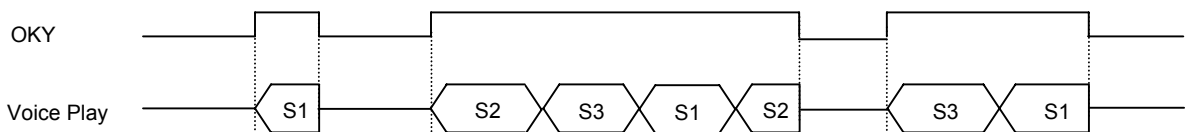

(i). Level-Sequential + Edge-Loop Function

(i-1) OKY (L/U/R) = S1 S2 S3

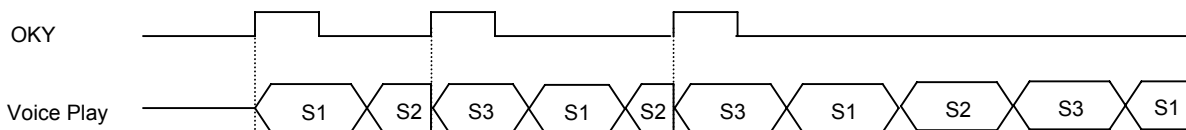

(i-2) OKY (L/U/R) = S1 S2 S3, Loop On/Off is enabled.

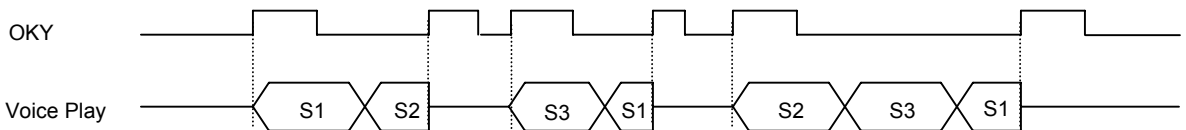

(i). Voice-Select Function

(j-1) OKY (E/U/R) = S1 S2 S3, IO1 (E/U/I) = OKY's sentence

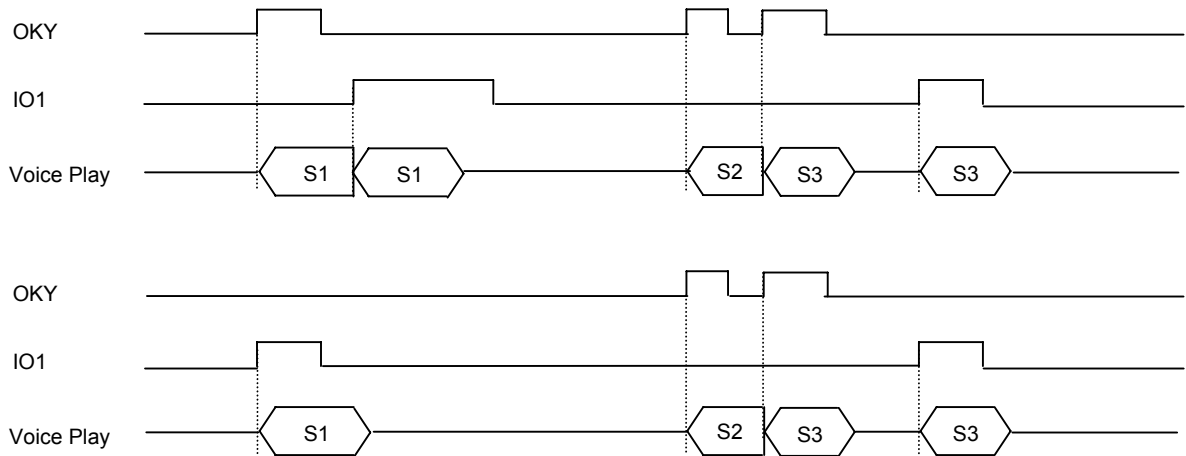

(j-2) OKY (E/U/R) = S1 S2 S3, IO1 (L/U/R) = OKY's sentence

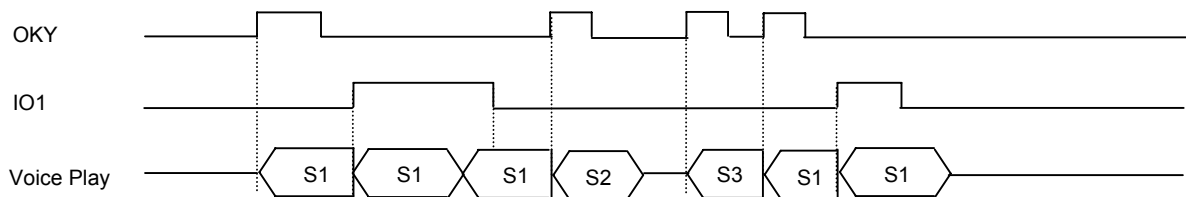

(k). Alarm/Snooze Function

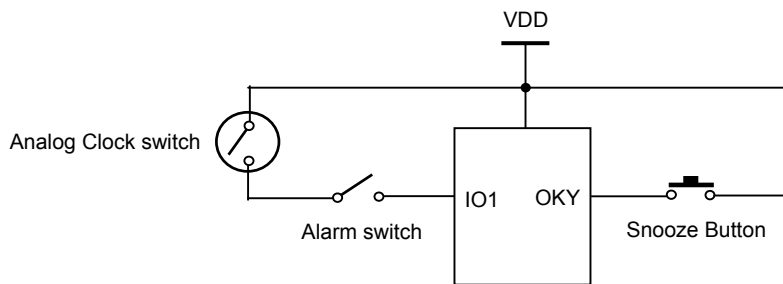

(k-1) OKY (E/U/R) = S1 S2 S3 S4, IO1 (L/x/R) = S5, Loop Sentence = S6, Jump Sentence = S7

If S1 is 5 minutes mute, S2 is 4 minutes mute, S3 is 3 minutes mute, S4 is 3 minutes mute,

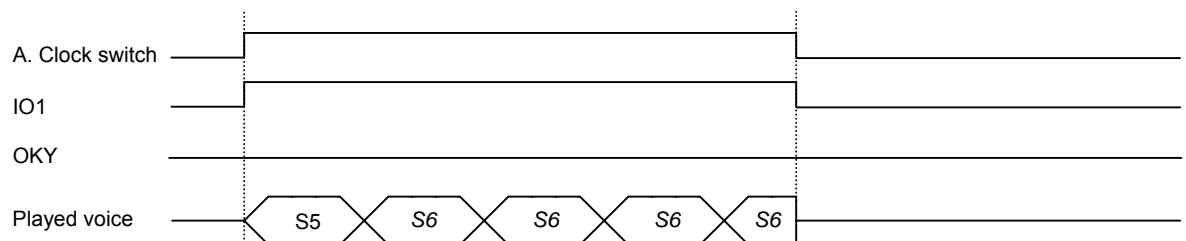

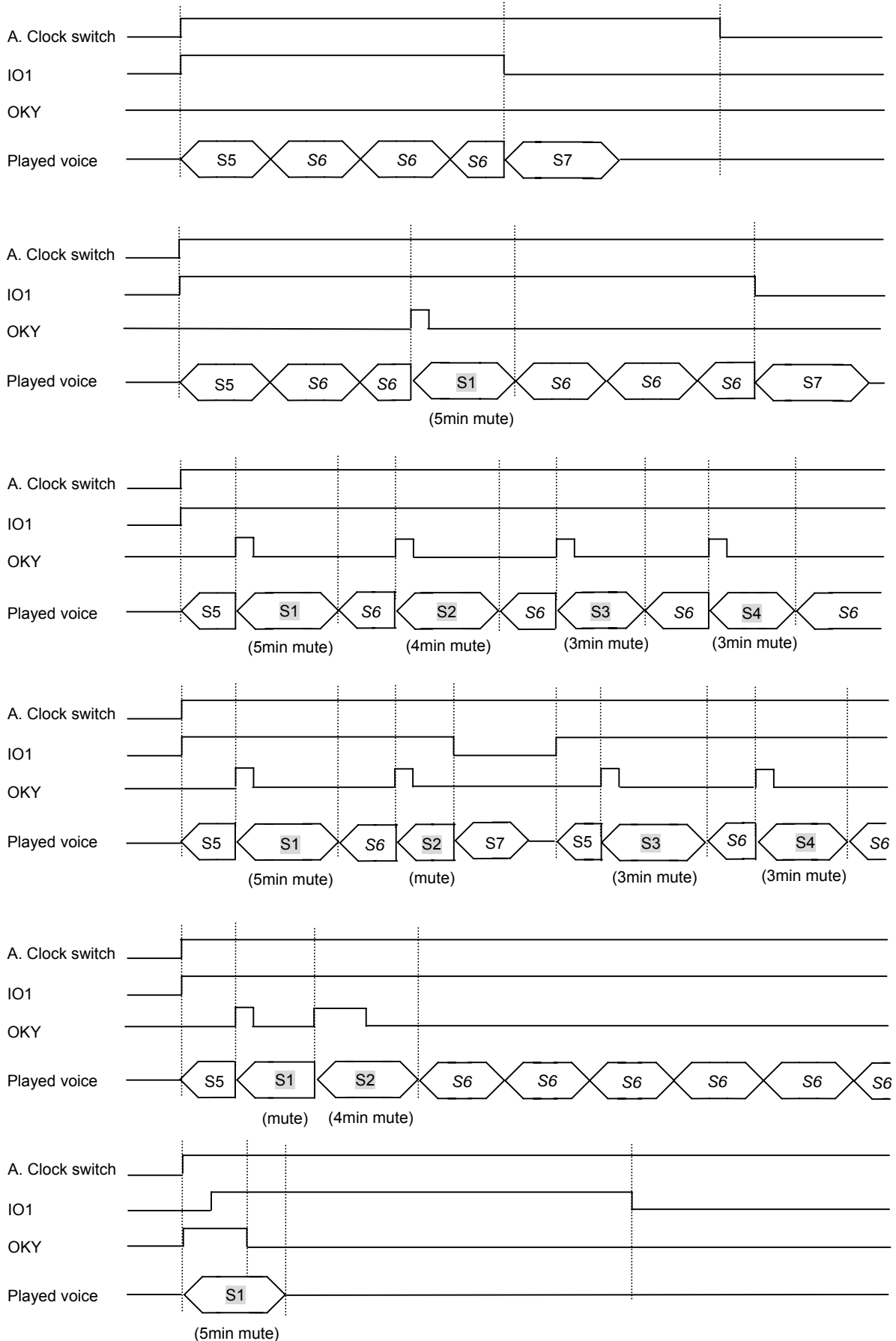

※ If OKY is triggered first and hold, IC can't detect IO1 trigger signal because the trigger mode follows OKY (E/U/R).

9. APPLICATION

(1) 2 triggers with 1 LED (Sink)

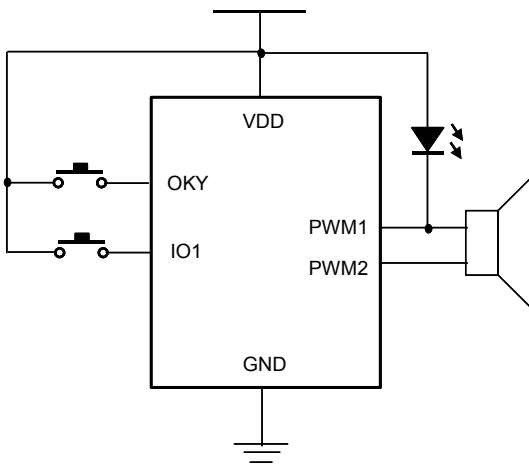

(2) 1 trigger with 2 LEDs (Sink)

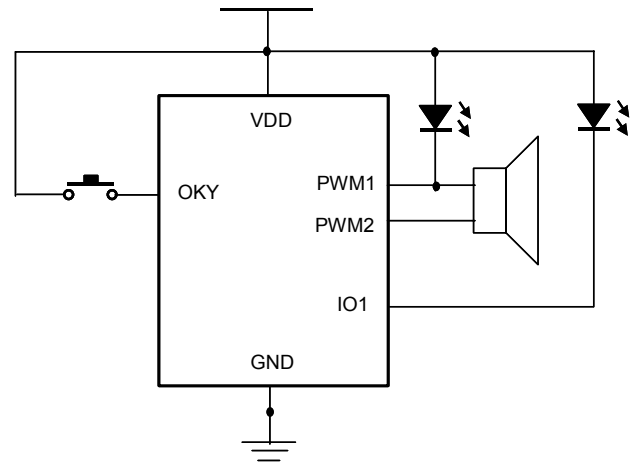

(3) 1 trigger with 1 LED (Sink) and 1 motor (Drive)

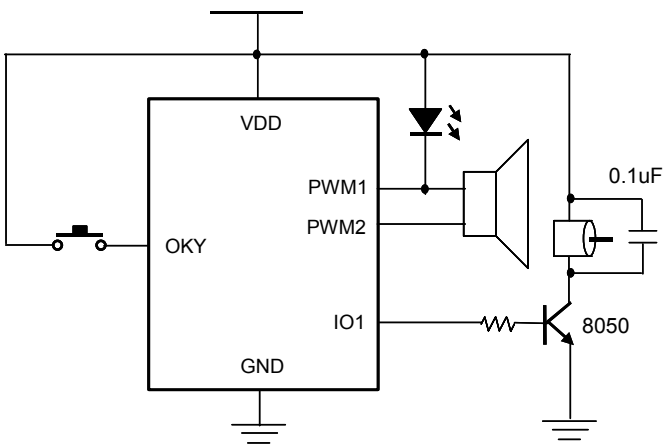

(4) 1 trigger with 1 LED (Sink) and 1 motor (Sink)

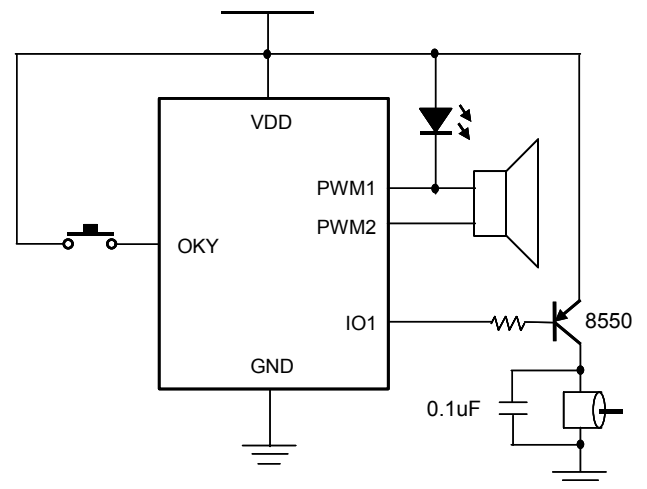

* Please contact Nyquest or her agents if users want to add any power capacitor between VDD and GND.

10. BONDING DIAGRAM

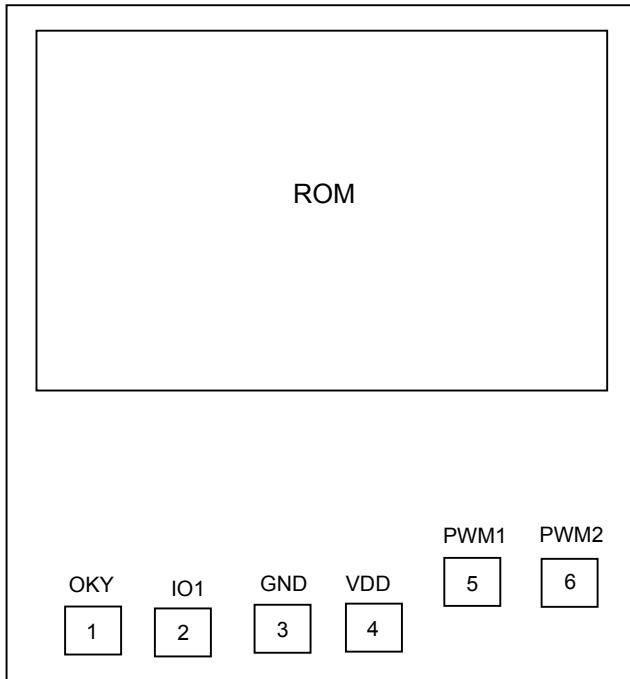

* The IC substrate must be connected to GND or Floating.