



九齊科技股份有限公司  
Nyquest Technology Co., Ltd.

DATA SHEET

# NY3B Series

---

## 2 I/O Single-Chip Speech Synthesizer

**Version 2.0**

**Nov. 22, 2023**

---

NYQUEST TECHNOLOGY CO. reserves the right to change this document without prior notice. Information provided by NYQUEST is believed to be accurate and reliable. However, NYQUEST makes no warranty for any errors which may appear in this document. Contact NYQUEST to obtain the latest version of device specifications before placing your orders. No responsibility is assumed by NYQUEST for any infringement of patent or other rights of third parties which may result from its use. In addition, NYQUEST products are not authorized for use as critical components in life support devices/systems or aviation devices/systems, where a malfunction or failure of the product may reasonably be expected to result in significant injury to the user, without the express written approval of NYQUEST.

## Revision History

<b>Version</b>	<b>Date</b>	<b>Description</b>	<b>Modified Page</b>
1.0	2013/08/31	Formal release.	-
1.8	2014/11/24	Modify Power-On-Play description.	4, 6
1.9	2020/03/20	Add NY3B007D	3, 5
2.0	2023/11/22	Add NY3B003D, N3B010D, and NY3B014D	3, 5

## 1. 概述

NY3B系列產品為單晶片 CMOS 語音合成 IC，共有6個母體分別為 **NY3B003D**、NY3B007D、**NY3B010D**、**NY3B014D**、NY3B017C 和 NY3B021C。具有2個I/O腳，利用精準的內阻震盪故不需外加震盪電阻，只有一組 PWM輸出，故無須再外加任何零件。語音合成方式為 **4-bit/5-bit Mixed Advanced LOG-PCM**，搭配 **9-bit PWM** 硬體輸出，可以提供很好的音質。藉由製造過程中更換Code光罩，可將不同的語音資料寫入ROM中。用戶可使用簡便的 Q-Speech 和 Quick-IO 工具軟體來快速地進行開發。

## 2. 功能

(1). 寬廣的工作電壓：1.6V ~ 6.4V。

(2). 共有6個母體，ROM大小及秒數如下：

	<b>NY3B003D</b>	NY3B007D	<b>NY3B010D</b>	<b>NY3B014D</b>	NY3B017C	NY3B021C
ROM	5400H (21504)	A800H (43008)	FC00H (64512)	15000H (86016)	1A400H (107520)	1F800H (129024)
4-bit, 6kHz	3.58s	7.17s	10.75s	14.34s	17.92s	21.50s
5-bit, 6kHz	2.87s	5.73s	8.60s	11.47s	14.34s	17.20s

*※ 注意：當選擇 Voice Quality Factor (VQF) =1，Bit 數接近 4-bit；當選擇 VQF =11，Bit 數接近 5-bit。*

(3). 有2個I/O腳: OKY和IO1可選擇作輸入腳或是輸出腳 (光罩選擇)。

(4). 語音最多可被分割成可被分割成16個語音段(Voice Section)，每段長度可不同。每一個語音段的長度(語音+靜音時間)最多可達 21.8 秒 (在6kHz取樣頻率下)。每一語音段中的語音+靜音長度必須為 200H (Hex) 的整數倍。

(5). 共有64個語音格(Voice Step)，可規劃成2個語音組(Voice Sentence)，OKY和IO1只能各指定一個語音組 (Sentence)，每個語音組最多可放32個語音格(Step)。每一語音格(Step)可指定任一個語音段(Section)和IOx的輸出搭配(當IOx設為輸出時)。

*※ 注意: 當只有一個語音組時，OKY語音組最多可放64個語音格(Step)。*

(6). 只有內建一組準確的頻率振盪器(+/- 3% 誤差)，並無提供外部震盪電阻選項。共有27種不同播放速度可供選擇，但只可選擇其中一種來使用。 (**新的播放速度必須搭配 NY3(B)\_FDB Ver.B**)

1	2	3	4	5	6	7	8	9	10
20.0kHz	17.1kHz	15.0kHz	13.3kHz	12.0kHz	10.9kHz	10.0kHz	9.2kHz	8.6kHz	8.0kHz
11	12	13	14	15	16	17	18	19	20
7.5kHz	7.1kHz	6.7kHz	6.3kHz	6.0kHz	5.7kHz	5.5kHz	5.2kHz	5.0kHz	4.8kHz
21	22	23	24	25	26	27			
4.6kHz	4.4kHz	4.3kHz	4.1kHz	4.0kHz	3.9kHz	3.8kHz			

(7). 輸入腳的輸入選項：(光罩選擇)

(a). 任一輸入腳可分別選擇 Edge/Level, Hold/Unhold, Retrigger/Irretrigger 不同的觸發方式組合。

(b). 任一輸入腳可選擇 CDS+1.5M、CDS、1.5M 的下拉電阻 或 Floating。(CDS+1.5M選項: 當按鍵按下時，IC內部為 1.5M 的下拉電阻；而當按鍵放開時，IC內部為 300K+1.5M 並聯 的下拉電阻 約250K。CDS選項: 當按鍵按下時，IC內部為 Floating；而當按鍵放開時，IC內部為 300K 的下拉電阻。)

- (c). 任一輸入腳可分別選擇Debounce時間：Long - 提供一般按鍵使用；Short - 提供彈跳開關使用。
- (d). OKY 輸入腳有2個Sentence的One-Key Sequential 的選擇，此時IO1只能當做輸出腳。
- (e). OKY 輸入腳可選擇是否有 Toggle On/Off 的功能 (1<sup>st</sup> 觸發 → 播放，2<sup>nd</sup> 觸發 → 停止，.....)，此時IO1只能當做輸出腳。

※ 注意: 按鍵輸入的優先順序為 OKY>IO1。

(8). 所有的輸出腳都可提供大電流來直推高亮度LED。(I<sub>ol</sub>=20mA @V<sub>DD</sub>=3V)

(9). 所有的輸出腳都有以下 9 種輸出選項：(光罩選擇)

- (a). Stop\_Low pulse：停止播放時送出低位準脈衝。
- (b). Stop\_High pulse：停止播放時送出高位準脈衝。
- (c). Busy\_High active：播放時送出高位準訊號。(Drive輸出)
- (d). Busy\_Low active：播放時送出低位準訊號。(Sink輸出)
- (e). LED 1.5Hz flash：播放時 LED 1.5Hz Sink輸出閃爍。
- (f). LED 3Hz flash：播放時 LED 3Hz Sink輸出閃爍。
- (g). LED dynamic 1/2：播放時 LED根據1/2聲音位準做Sink輸出動態閃爍。
- (h). LED dynamic 3/4：播放時 LED根據3/4聲音位準做Sink輸出動態閃爍。
- (i). QIO訊號: 可隨聲音作任意的輸出變化，每一個語音格(Step)可選擇一組QIO訊號，用戶使用此功能需先開啟Quick-IO編輯器來做QIO訊號編輯。

※ 注意: LED 1.5Hz / 3Hz flash 是指以 6kHz 的播放速度 時LED閃爍的頻率；不同的播放速度，LED閃爍的頻率也會不同。

(10). 特殊功能選項 "上電播放" (Power-On-Play, POP)：電池一上電立即播放一次 "上電播放語音組" (POP Sentence)，觸發模式固定為 Edge / Unhold。如果結合 "上電循環播放" (Power-On-Loop, POL) 功能，則該語音組會一直循環播放，觸發模式固定為 Level / Unhold / Irretrigger。"上電播放語音組" 為 IO1 的語音組，如果結合Toggle On/Off，則"上電播放語音組"為OKY 的語音組。

※ 注意：當選擇POP功能時，OKY 或 IO1 可以設為輸入或輸出腳；但是結合POL功能時，OKY 和 IO1 都只能設為輸出腳。

(11). 特殊功能選項 "內部觸發" (Internal-Feedback)：此功能有兩組。當OKY(IO1) 的聲音播放中被重覆觸發或聲音播放結束時，利用內部的Stop\_High-Pulse信號來自動觸發 IO1(OKY) 所指定的語音組(Internal-Feedback Path)，播放該語音組一次。

※ 注意: 當啟動此功能時，OKY(IO1) 只能當做輸入腳，且此時 OKY 不能當做 One-Key Sequential 和 Toggle On/Off 來使用。

(12). 一組 9-bit PWM 輸出，可直接驅動喇叭或蜂鳴片。

## 1. GENERAL DESCRIPTION

The NY3B series are single-chip voice synthesizing CMOS IC. There are 6 bodies: **NY3B003D**, NY3B007D, **NY3B010D**, **NY3B014D**, and NY3B017C and NY3B021C. Each body has two I/O pins. Through accurate internal oscillation, external R<sub>osc</sub> is unnecessary. There is only one PWM output for voice. Thus any external component is not required. Using **4-bit/5-bit Mixed Advanced LOG-PCM** algorithm with **9-bit PWM** hardware output, it can generate good sound quality. Customer's speech data can be programmed into ROM by changing one code mask during fabrication. Besides, two interactive software developing tools of "Q-Speech" & "Quick-IO" are user-friendly and quick for programming.

## 2. FEATURES

- (1). Wide operating voltage: 1.6V ~ 6.4V.
- (2). There are 6 bodies. ROM size and speech duration are as following.

	<b>NY3B003D</b>	NY3B007D	<b>NY3B010D</b>	<b>NY3B014D</b>	NY3B017C	NY3B021C
ROM	5400H (21504)	A800H (43008)	FC00H (64512)	15000H (86016)	1A400H (107520)	1F800H (129024)
4-bit, 6kHz	3.58s	7.17s	10.75s	14.34s	17.92s	21.50s
5-bit, 6kHz	2.87s	5.73s	8.60s	11.47s	14.34s	17.20s

*※ Note: When the Voice Quality Factor (VQF) is set as 1, it's close to 4-bit. When the VQF is set as 11, it's close to 5-bit.*

- (3). Two I/O pins: OKY and IO1 can be either input or output pin (Mask option).
- (4). The total voice duration can be partitioned up to 16 *Voice Sections*. Each *Voice Section* length is flexible. Each voice length (voice+mute) can be individually up to 21.8 seconds at 6kHz S.R.. The *Voice Section* length of "voice length + mute length" must be the multiple of 200H (Hex).
- (5). Total 64 *Voice Steps* are available for 2 *Voice Sentences*. OKY and IO1 can assign only one *Sentence* independently. Each *Sentence* can use maximum 32 *Voice Steps*. Each *Step* can specify one *Voice Section* and enable/disable IOx output option if IOx is set as an output.

*※ Note: When there is only one sentence, OKY sentence can use maximum 64 Voice Steps.*

- (6). Only build in an accurate internal oscillator of +/- 3% tolerance, no external R oscillator. There are 27 kinds of options for play speed, but user can only select one of them to use. **(New play speed must be cooperated with NY3(B)\_FDB Ver.B or later version. )**

1	2	3	4	5	6	7	8	9	10
20.0kHz	17.1kHz	15.0kHz	13.3kHz	12.0kHz	10.9kHz	10.0kHz	9.2kHz	8.6kHz	8.0kHz
11	12	13	14	15	16	17	18	19	20
7.5kHz	7.1kHz	6.7kHz	6.3kHz	6.0kHz	5.7kHz	5.5kHz	5.2kHz	5.0kHz	4.8kHz
21	22	23	24	25	26	27			
4.6kHz	4.4kHz	4.3kHz	4.1kHz	4.0kHz	3.9kHz	3.8kHz			

- (7). Input option for input pin: (Mask option)
  - (a). Each input can select Edge/Level, Hold/Unhold and Retrigger/Irrtrigger trigger modes.

- (b). Each input can select CDS+1.5M, CDS, 1.5M pull-low resistor or Floating type.  
(CDS+1.5M option: Only 1.5M pull-low resistance at key-pressed, and 1.5M+300K in parallel pull-low resistance around 250K at key-released. CDS option: Floating at key-pressed, and 300K pull-low resistance at key-released.)
- (c). Each input can select Debounce time: Long debounce for push-button. Short debounce for fast switch.
- (d). OKY input can select One-Key Sequential for 2 Sentences independently. At this setup, IO1 is fixed as output pin.
- (e). OKY input pin can select Toggle On/Off function (1<sup>st</sup> Trigger → play, 2<sup>nd</sup> trigger → stop, .....). At this setup, IO1 is fixed as output pin.

*※ Note: Input priority is OKY > IO1.*

(8). All output pins support large-current output and can directly drive high brightness LED. ( $I_{ol}=20\text{mA}$  @ $V_{DD}=3\text{V}$ )

(9). There are 9 kinds of output option for all output pins:

- (a). Stop\_Low pulse: Low active stop-pulse output whenever device stop playing.
- (b). Stop\_High pulse: high active stop-pulse output whenever device stop playing.
- (c). Busy\_High active: high active signal output during playing. (Drive output)
- (d). Busy\_Low active: low active signal output during playing. (Sink output)
- (e). LED 1.5Hz flash: 1.5Hz sink signal output to drive LED during playing.
- (f). LED 3Hz flash: 3Hz sink signal output to drive LED during playing.
- (g). LED dynamic 1/2: according to 1/2 sound level, dynamic sink signal output to drive LED during playing.
- (h). LED dynamic 3/4: according to 3/4 sound level, dynamic sink signal output to drive LED during playing.
- (i). QIO signal: arbitrary output with voice. Each Voice Step can select one set of QIO signal and user can edit the QIO signal by “Quick-IO” editor.

*※ Note: Where 1.5Hz or 3Hz is the LED flash rate at 6kHz sample rate. For different play speed, the LED flash rate is different from original 1.5Hz or 3Hz.*

(10). “Power-On-Play” special function (POP): When power is on, play the POP Sentence one time. The trigger mode is fixed as Edge / Unhold. To cooperate with Power-On-Loop (POL) function, the POP Sentence will be played in loop. The trigger mode is fixed as Level / Unhold / Irretrigger. The POP Sentence is IO1 sentence, however, if cooperates with Toggle On/Off, POP Sentence is OKY sentence.

*※ Note: When POP function is selected, OKY or IO1 can be set either input or output. But when to cooperate with POL function, both OKY and IO1 must be set as output.*

(11). “Internal-Feedback” special function: There are 2 sets of this function. When the playing sentence of OKY(IO1) is retriggered or over, continue to play the assigned sentence of IO1(OKY) through internal Stop\_High-Pulse signal (Internal-Feedback Path).

*※ Note: When enable this function, OKY(IO1) is fixed as input pin. Meanwhile, OKY cannot use One-Key Sequential or Toggle On/Off function.*

(12). One 9-bit PWM output can directly drive speaker or buzzer.

### 3. BLOCK DIAGRAM

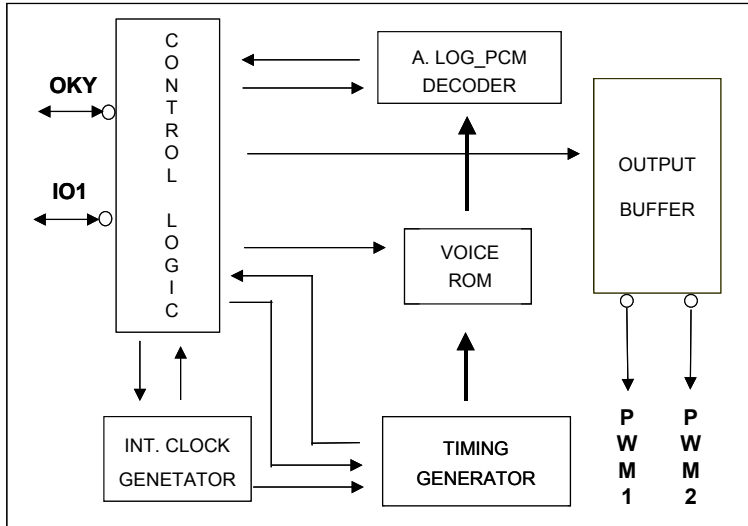

### 4. PAD DESCRIPTION

Pad Name	Pad No.	ATTR.	Description
OKY	1	I/O	Input or output pin. To be input, active high.
IO1	2	I/O	Input or output pin. To be input, active high.
GND	3	Power	Negative power.
VDD	4	Power	Positive power.
PWM1	5	O	PWM output 1.
PWM2	6	O	PWM output 2.

### 5. DEVELOPMENT, DEMONSTRATION

User can use “Q-Speech” & “Quick-IO” software tools to develop the desired functions. After finishing the code programming, user will get 2 files of “.bin” and “.htm”, the binary file and function check list. Through “FDB\_Writer” operation, user can download the “.bin” file into NY3(B)\_FDB-02 Flash Demo Board to demonstrate the NY3B function. Once the function has been approved, user only need to send the “.bin” file to Nyquest for code release. For more details, please refer to “Q-Speech” & “Quick-IO” user manual.

<i>2Mb Flash Demo board</i>	<i>NY3(B)_FDB-02 (Ver.B)</i>
Max. demo body	NY3B021C

### 6. ABSOLUTE MAXIMUM RATING

Symbol	Rating	Unit
VDD~GND	-0.5 ~ +7.5	V
V <sub>in</sub>	GND-0.3 < V <sub>in</sub> < VDD+0.3	V
V <sub>out</sub>	GND < V <sub>out</sub> < VDD	V
T <sub>op</sub> (operating)	-0 ~ +70	°C
T <sub>st</sub> (storage)	-55 ~ +150	°C

**7. DC CHARACTERISTICS**

Symbol	Parameter	Min.	Typ.	Max.	Unit	Condition
VDD	Operating voltage	1.6	3.0	6.4	V	
I <sub>sb</sub>	Standby current, VDD=3V/4.5V		0.2	0.5	uA	No loading
I <sub>op</sub>	Operating current	VDD=3V	830			
		VDD=4.5V	2100			
I <sub>ih</sub>	Input current: OKY (1.5M pull-low)			2	uA	VDD=3V
				5		VDD=4.5V
I <sub>ih</sub>	Input current: OKY (CDS: 300k pull-low)			10	uA	VDD=3V
				25		VDD=4.5V
I <sub>oh</sub>	Output drive current		-10		mA	VDD=3V, V <sub>oh</sub> =1.0V
			-20			VDD=4.5V, V <sub>oh</sub> =2.2V
I <sub>ol</sub>	Output sink current		20		mA	VDD=3V, V <sub>ol</sub> =1.0V
			34			VDD=4.5V, V <sub>ol</sub> =1.0V
I <sub>oh</sub>	PWM1, PWM2 output current		-60		mA	VDD=3V, V <sub>oh</sub> =1.5V
		I <sub>ol</sub>		60		
ΔF/F	Frequency deviation by voltage drop		VDD=3V	1		%
		VDD=4.5V	-0.5		$\frac{F_{osc(4.5v)} - F_{osc(3.0v)}}{F_{osc(4.5v)}}$	
ΔF/F	Frequency lot deviation, (VDD=3V)	-3.0		3.0	%	$\frac{F_{max(3.0v)} - F_{min(3.0v)}}{F_{max(3.0v)}}$
F <sub>osc</sub>	Oscillation Frequency	614	768	800	kHz	VDD=1.6~6.4V

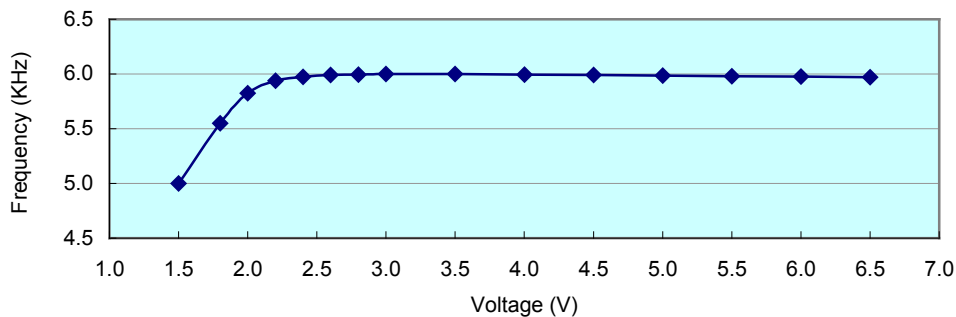
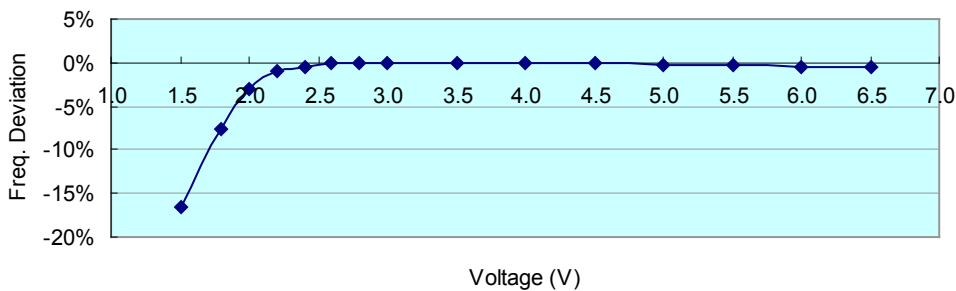
**Voltage vs Frequency (SR=6.0KHz@3V)**

**Voltage vs Freq. Deviation (SR=6.0KHz@3V)**



## 8. TIMING DIAGRAM

### (1) Debounce Time

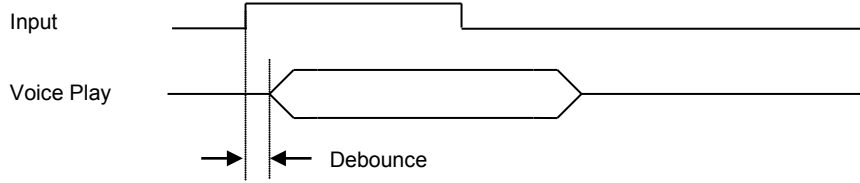
#### (a). Trigger while no playing voice



※ Debounce time is configured by 6 kHz S.R and the value is fixed. That is, Long debounce = 20ms, Short debounce = 50us

#### (b). Trigger While playing voice

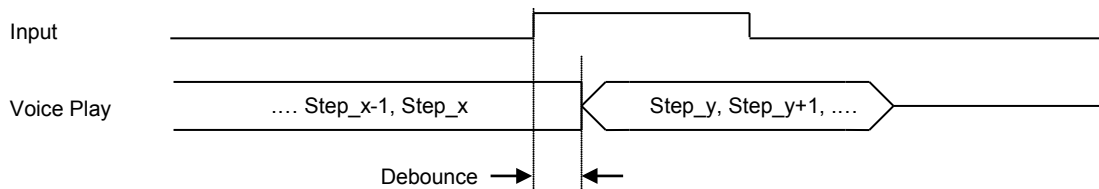

※ Debounce Time is configured by the S.R. of Step\_x. At S.R. = 6kHz, Long debounce = 20ms, Short debounce = 50us

For example, if Step\_x S.R. = 8kHz, Long debounce =  $20ms * (6k/8k) = 15ms$ , Short debounce =  $50us * (6k/8k) = 37.5us$

### (2) Input Priority

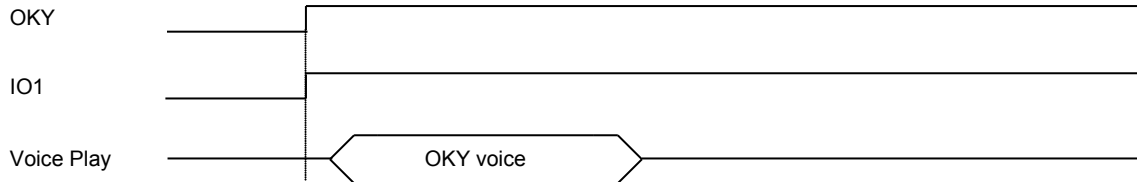

※ Priority: OKY >

### (3) Output Signal

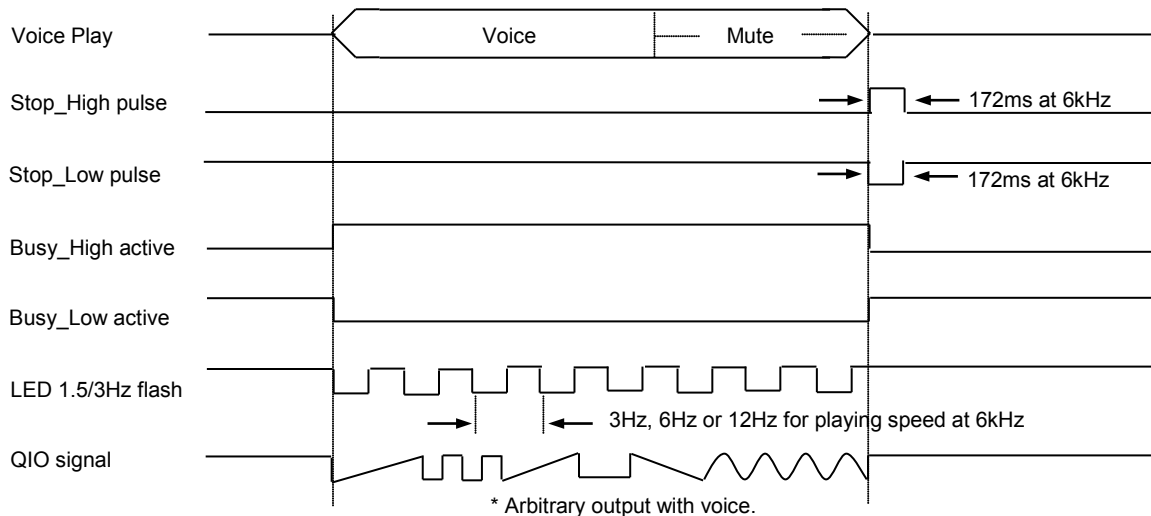

LED dynamic 1/2 or 3/4: When the voice amplitude is higher than 1/2 or 3/4 level, LED will be ON, i.e. output signal is low.

**(4) Basic Operation**

**(a). Edge mode, Edge trigger**

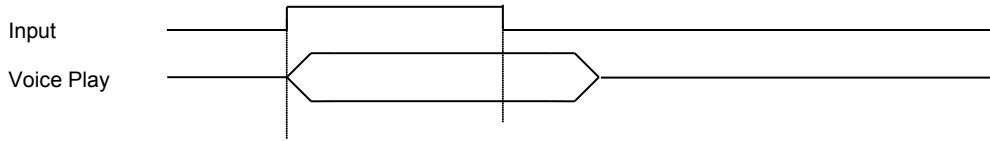

**(b). Edge mode, Level trigger**

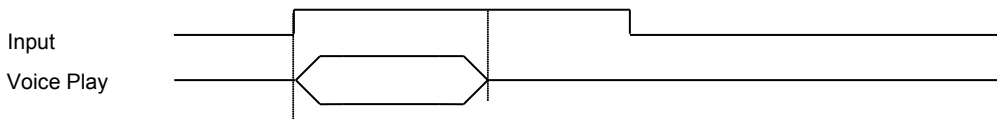

**(c). Level mode, Edge trigger**

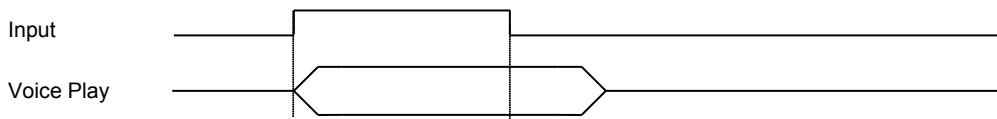

**(d). Level mode, Level trigger**

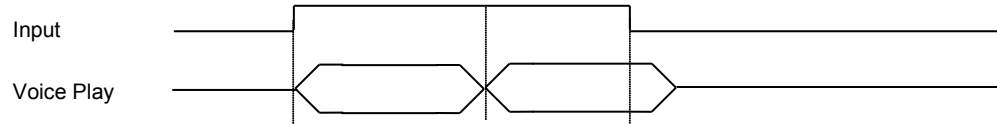

**(e). Retrigger mode**

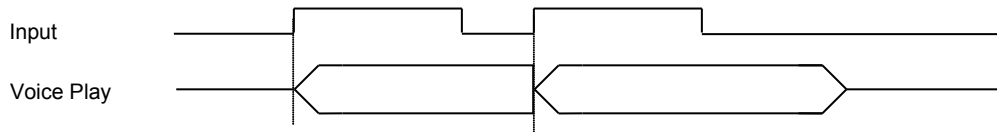

**(f). Irretrigger mode**

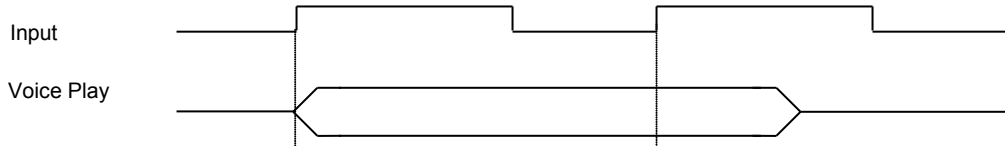

**(g). Retrigger mode, first key priority**

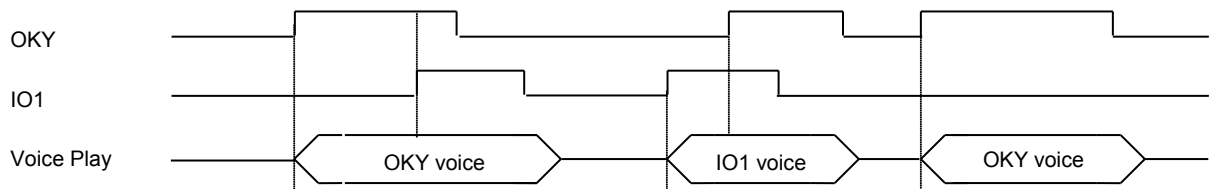

(5) Advanced Operation

(a). Different Input Reload

(a-1) OKY (E/U/R)=S1, IO1(E/U/R)=S2 (S1 means Sentence 1)

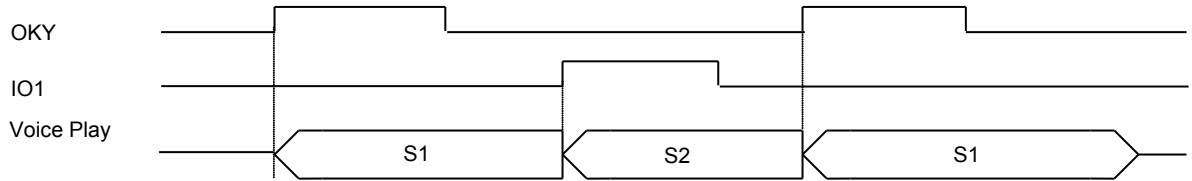

(a-2) OKY (E/U/R) =S1, IO1 (L/x/x) =S2

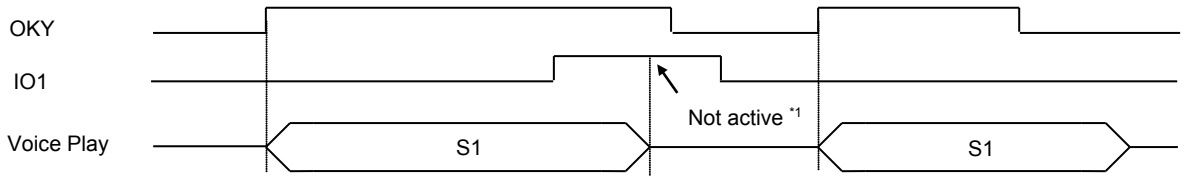

\*1: If you press IO1 during OKY voice playing, at the moment of S1 end, the trigger mode follows OKY

(a-3) OKY (E/U/I) =S1, IO1 (E/x/x) =S2

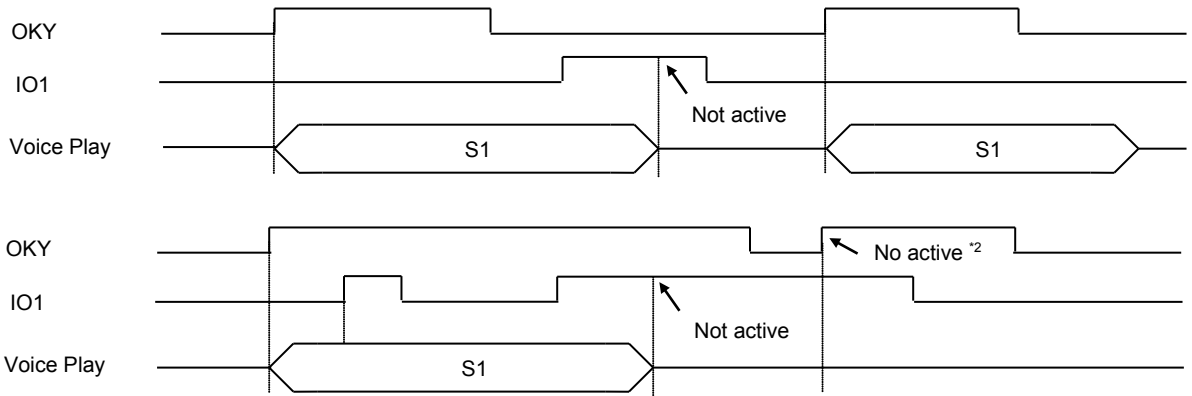

\*2: Because IO1 signal is still high, in the same time IC can't accept the OKY Edge signal.

(a-4) OKY (E/U/I) =S1, IO1 (L/x/x) =S2

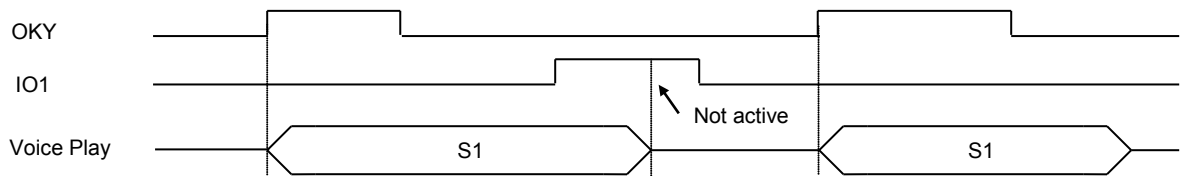

(a-5) OKY (L/U/x) =S1, IO1 (E/x/x) =S2

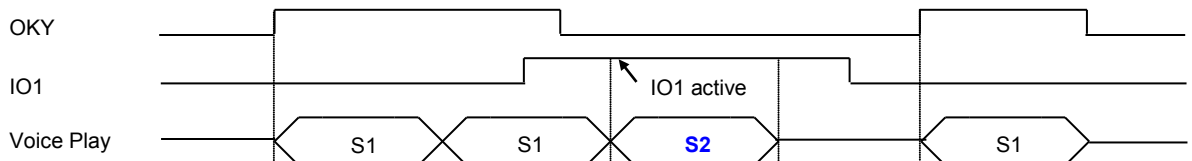

※ In the time of Sentence end: When S1 end, the trigger mode follows OKY (L/U/x). When S2 end, it follows IO1 (E/x/x).

※ Once S2 is played (just leave S1 ending), the trigger mode follows IO1 (E/x/x) immediately.

(a-6) OKY (L/U/x) =S1, IO1 (L/U/I) =S2

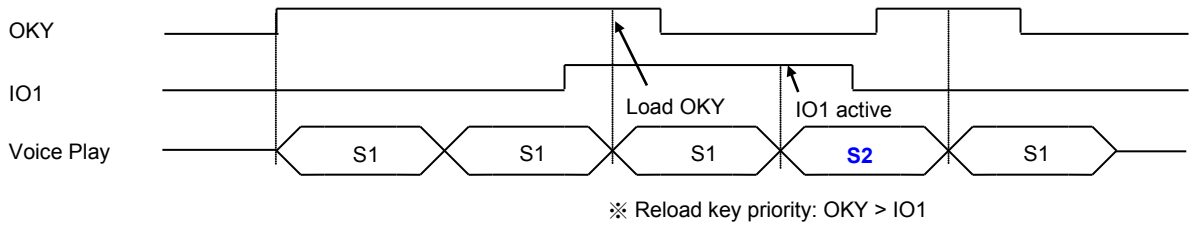

(a-7) OKY (L/U/x) =S1, IO1 (L/U/x) =S2

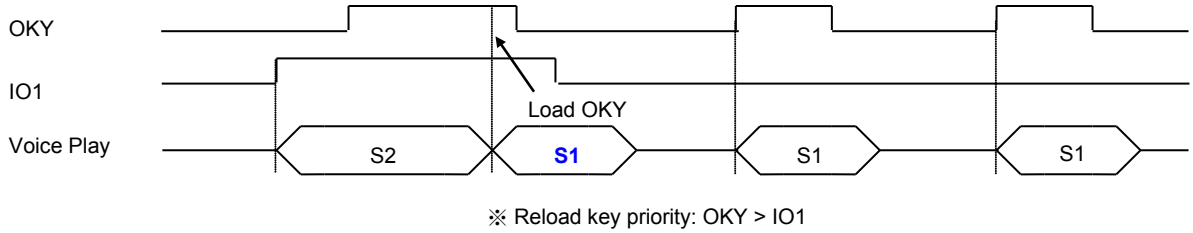

**(b). One-Key Sequential Function (Only 2 Sentences)**

(b-1) OKY (E/U/R) =S1 S2, IO1 must be fixed as output mode.

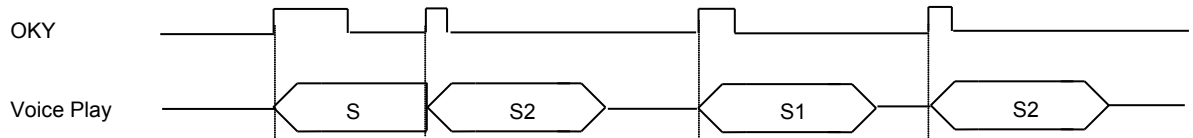

(b-2) OKY (L/U/R) =S1 S2, IO1 must be fixed as output mode.

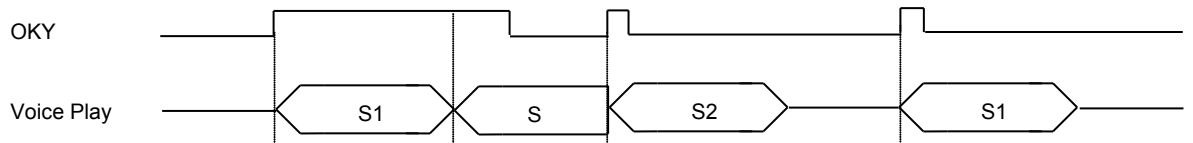

**(c). Toggle On/Off Function**

(c-1) OKY (E/U/R) =S1, IO1 must be fixed as output mode.

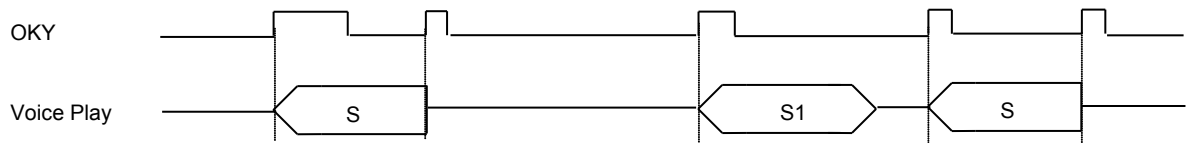

(c-2) OKY (L/U/R) =S1, IO1 must be fixed as output mode.

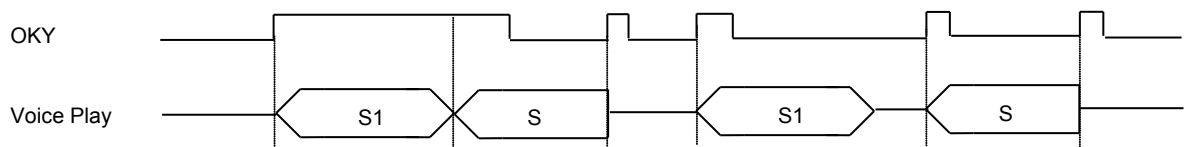

**(d). External Feedback Function ( IO1 is output and connected to OKY input )**

OKY (E/U/I) = S1, IO1= Busy\_low (When not playing voice, IO1 is high.)

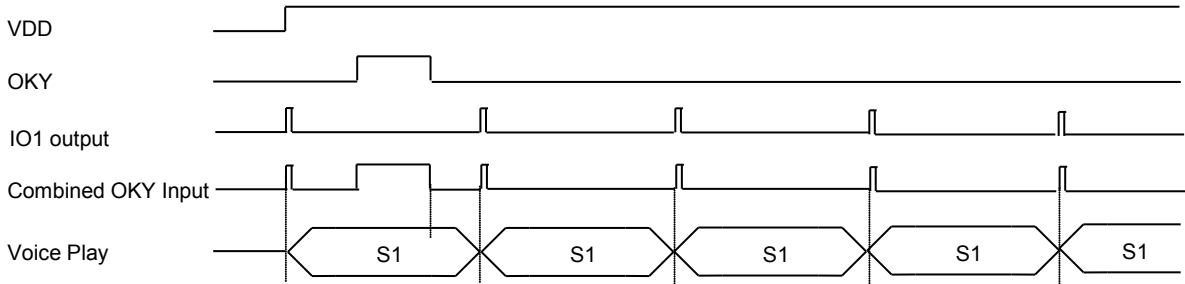
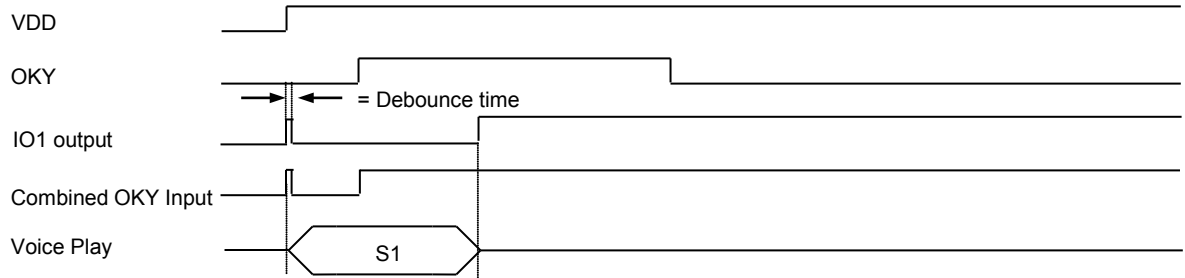

※ When power on, IO1 will generate a high pulse at Busy\_low status and the duration is equal to debounce time.

**(e). Internal-Feedback Function**

Each sentence can assign an Internal-Feedback Path to play a fixed sentence after IO's sentence stop.

(e-1) OKY (L/U/I) = S1, IO1 = 3Hz Sink with S1 only, Internal-Feedback Path = S2

If S1 is optional with Internal-Feedback Path,

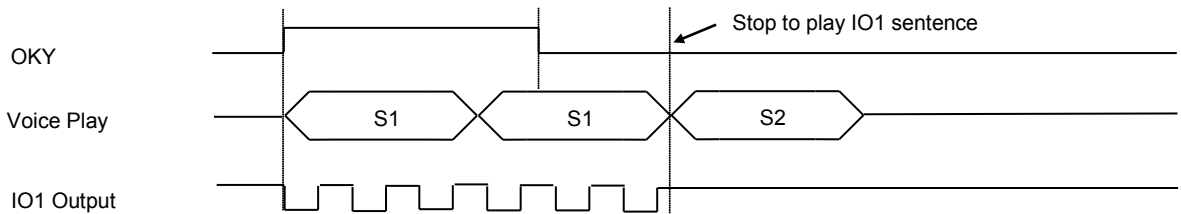

(e-2) OKY (L/H/I) = S1, IO1 (x/x/R) = S2, Internal-Feedback Path = S2

If S1 is optional with Internal-Feedback Path,

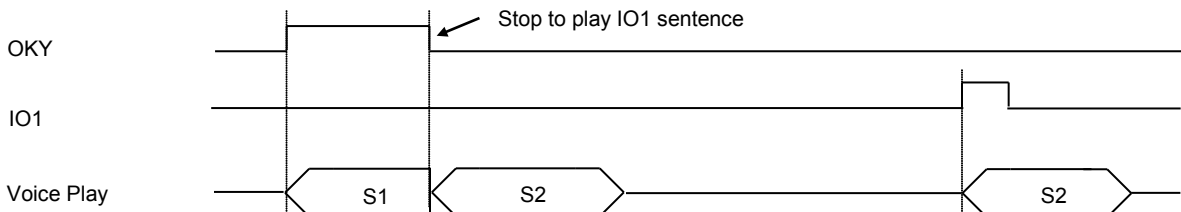

**(f). Power-On-Play (POP) Function ( POP sentence is fixed as S2 of IO1 sentence )**

(f-1) POP (E/U/I) = S2, OKY = S1, IO1 = 3Hz Sink with S1 and S2

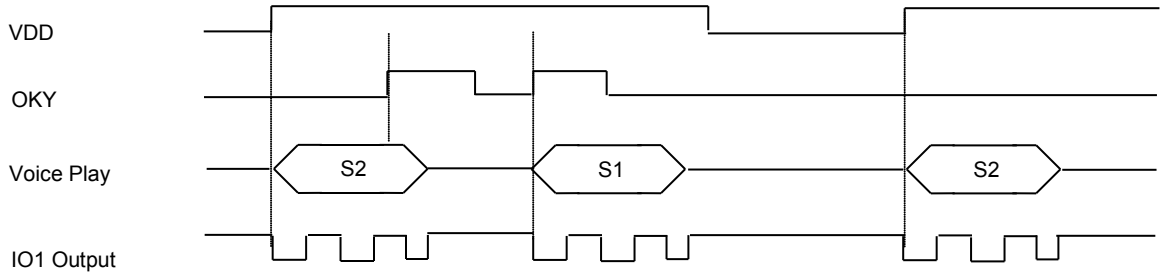

(f-2) POP (L/U/I) = S2, OKY = 3Hz Sink, IO1 = 3Hz Sink, Power-On-Loop (POL) is enabled.

When both OKY and IO1 are set as output and the trigger mode of Power-On-Play is set as Level mode, cooperating with Power-On-Loop (POL) function, play voice in loop.

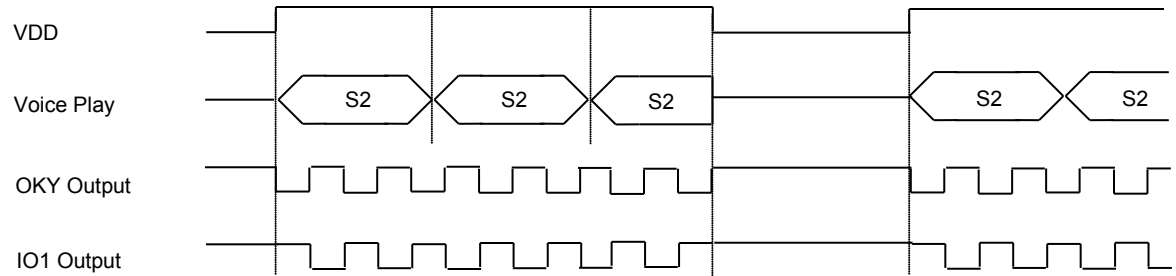

9. APPLICATION

(1) 2 triggers with 1 LED (Sink)

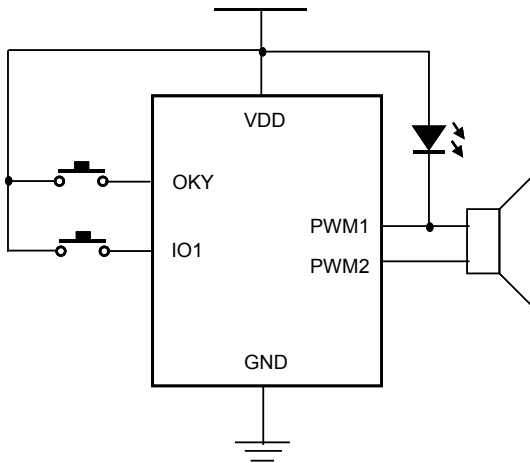

(2) POP trigger with 1 trigger and 1 LED (Sink)

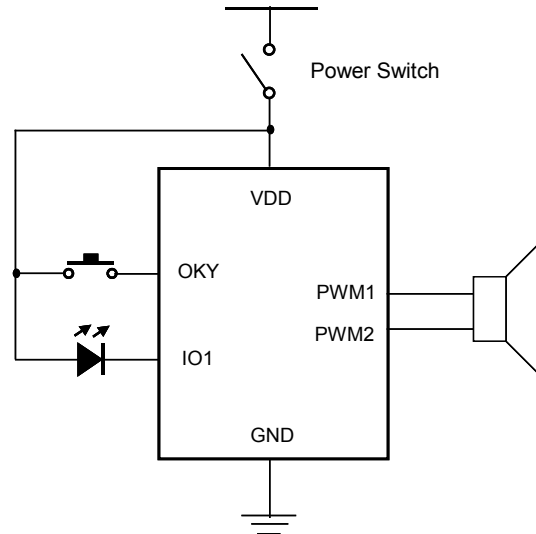

(3) 1 trigger with 1 LED (Sink) and 1 motor (Drive)

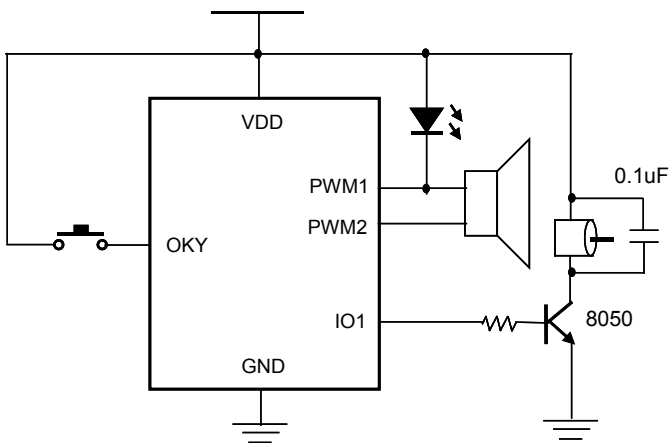

(4) 1 trigger with 1 LED (Sink) and 1 motor (Sink)

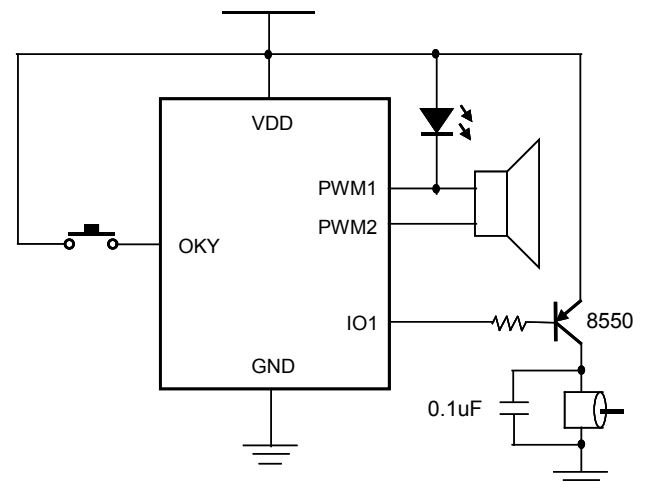

*\* Please contact Nyquest or her agents if users want to add any power capacitor between VDD and GND.*

**10. DIE PAD DIAGRAM**

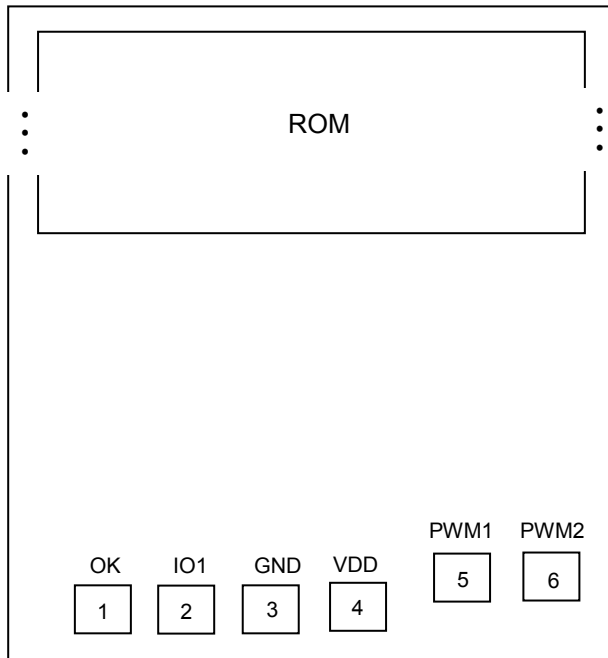

\* The IC substrate must be connected to GND or Floating.